

NUCLEAR RAMJET AND SCRAMJET PROPULSION

© M. Ragheb
8/21/2022

“All technology that is sufficiently advanced is indiscernible from magic.”
Arthur C. Clarke

INTRODUCTION

The Supersonic Low Altitude Missile (SLAM), also dubbed “The Big Stick,” was conceived around 1964 as a third weapon system in addition to the Inter-Continental Ballistic Missiles (ICBMs) and strategic bombers for delivering retaliatory strikes in the event of a nuclear conflict. The SLAM, a nuclear-powered cruise missile would have an unlimited range that could loiter following the terrain at low altitude, hence evading long-range radar, for weeks on end before dropping multiple payloads behind enemy lines.

The principle behind the nuclear ramjet or pipe-stove is that the forward motion of the vehicle pushed air in through the front of the vehicle or the ram effect. A compact nuclear reactor then heated the air, and the hot air expanded at high speed out through a nozzle at the back, providing thrust without the need for a chemical fuel. A rifle bullet going at 2,500 fps, is moving at a half mile a second, 30 miles a minute, 1800 miles an hour, or supersonic Mach 2.5.

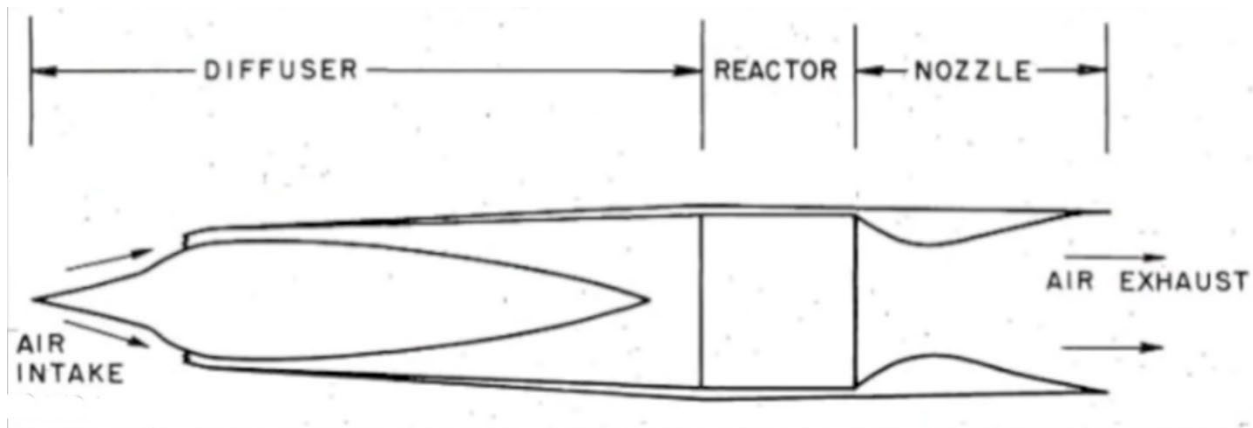

Figure 1. A nuclear ramjet engine rocket on a cruise missile gives it an unlimited range and makes it undetectable as it cruises at a low altitude following the terrain. It does not require radiation shielding for a crew, except to its electronic guidance components.

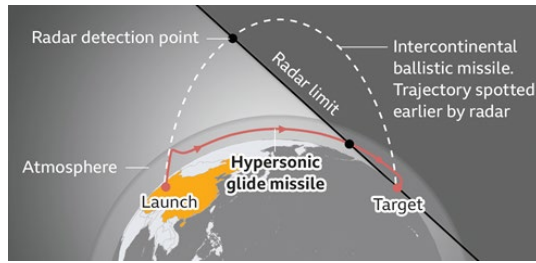

Figure 2. Hypersonic Glide Missile, HGM is harder to detect on radar than an Intercontinental Ballistic Missile, ICBM. Source: BBC.

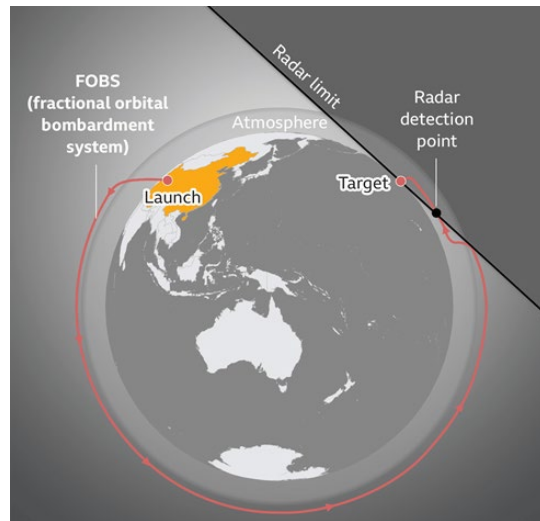
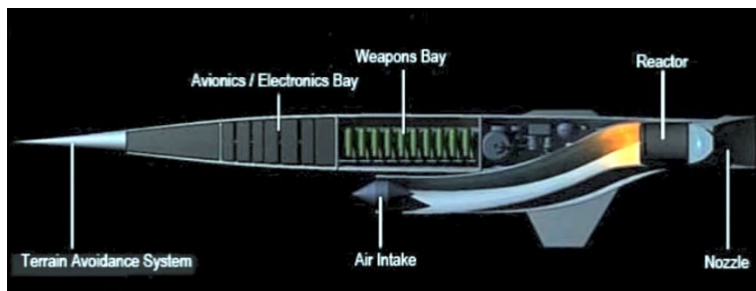

Figure 3. Fractional Orbital Bombardment System, FOBS. Source: BBC.



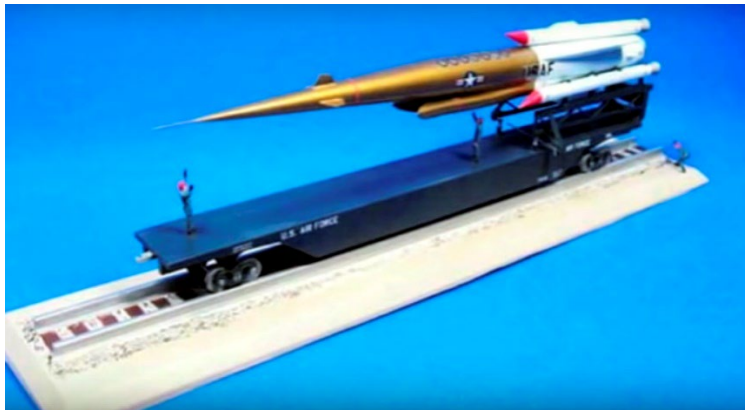

Figure 4. Mach 3.5 supersonic SLAM Reactor and missile configuration using 3 booster rockets.

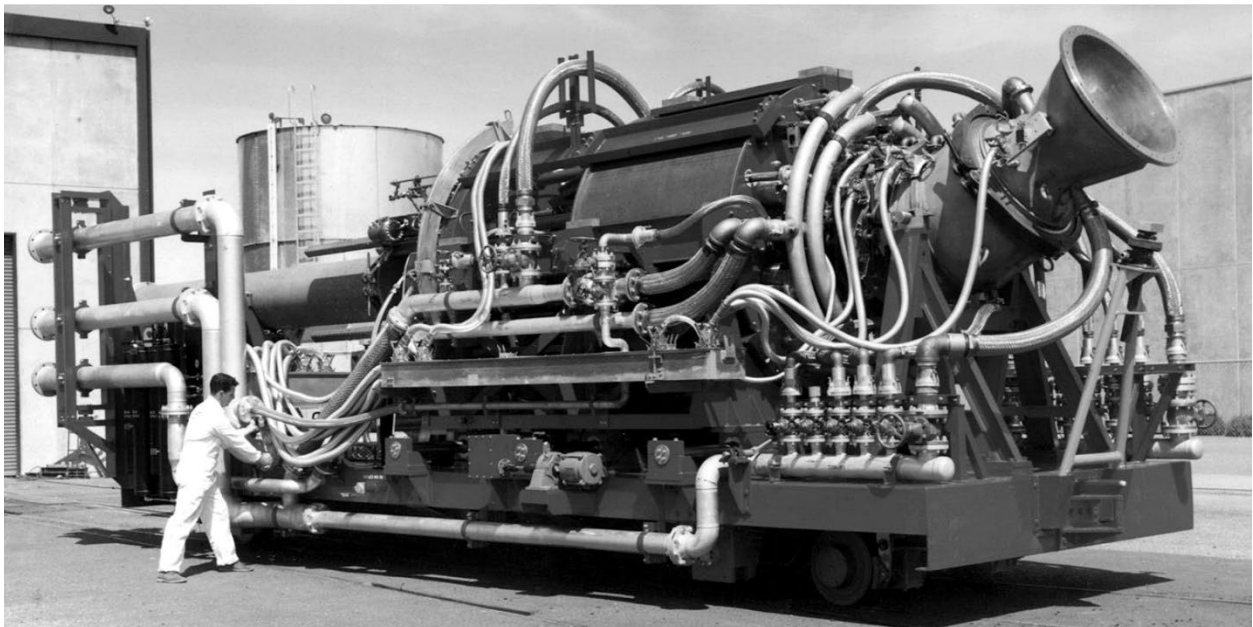

Figure 5. Nuclear reactor and nozzle Torre IIA.

An issue for the use of chemical fuel is it that it takes 20 times the fuel need for a transatlantic or coast to coast commercial flight for the trip, and fuel is by far the most expensive part of flying already. So if the cost per passenger were \$500 for a 7hr flight the civilian carriers would need to charge \$10k to make it a 1.5 hrs transatlantic trip. If five people got together they could charter a private jet for less. There will never be a civilian market for this option unless the nuclear propulsion is used. The military will probably develop the technology that will later migrate to the civilian sector.

Advances in metallurgy and materials science are needed for a successive implementation. Pneumatic motors necessary to control the reactor in flight had to operate while red-hot and in the presence of intense radiation. The need to maintain supersonic speed at low altitude and in all kinds of weather meant the reactor has to survive high temperatures and conditions that would melt the metals used in most jet and rocket engines. Beryllium oxide ceramic or carbon nanotubes fuel elements and boron nitride or graphite structures would have to be used.

The USA efforts to build the nuclear-powered SLAM, was named project Pluto. From 1957-1964 the USA worked on a nuclear powered cruise missile, which would carry 16 nuclear munitions to targets in the USSR. The reactor would be unshielded and was colossal in size using a moderator in a thermal neutron spectrum. A fast neutron spectrum reactor would be more compact in size. For testing purposes, an electrical heating system can model the reactor heat input.

The large amount of radiation it generated in flight was considered a feature at the time. However, even though a full scale reactor and engine were built, the project was canceled because the system was considered both highly problematic from an engineering standpoint and also provocative. The SLAM was nixed in 1964. Some believed it would motivate the Soviet Union to build a similar device, and all in all ballistic missiles were far less problematic.

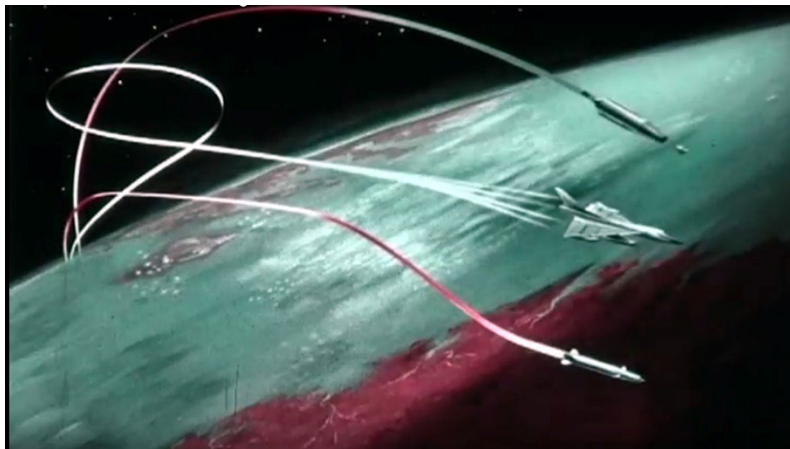

Figure 6. Initial Conceptualization of a Triad of Supersonic Low Altitude Missile (SLAM), Inter Continental Ballistic Missiles (ICBMs) and strategic bombers.

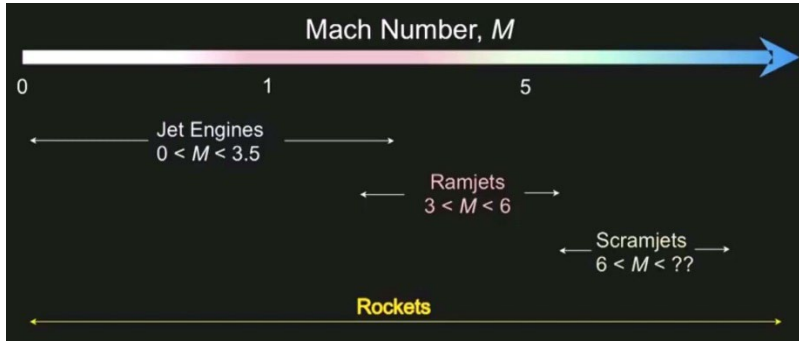
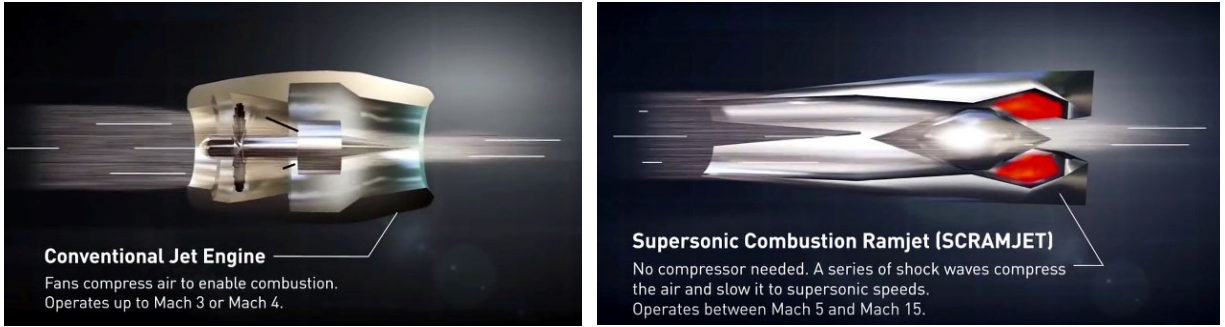

Figure 7. Operation range of Supersonic Combustion Ramjet.

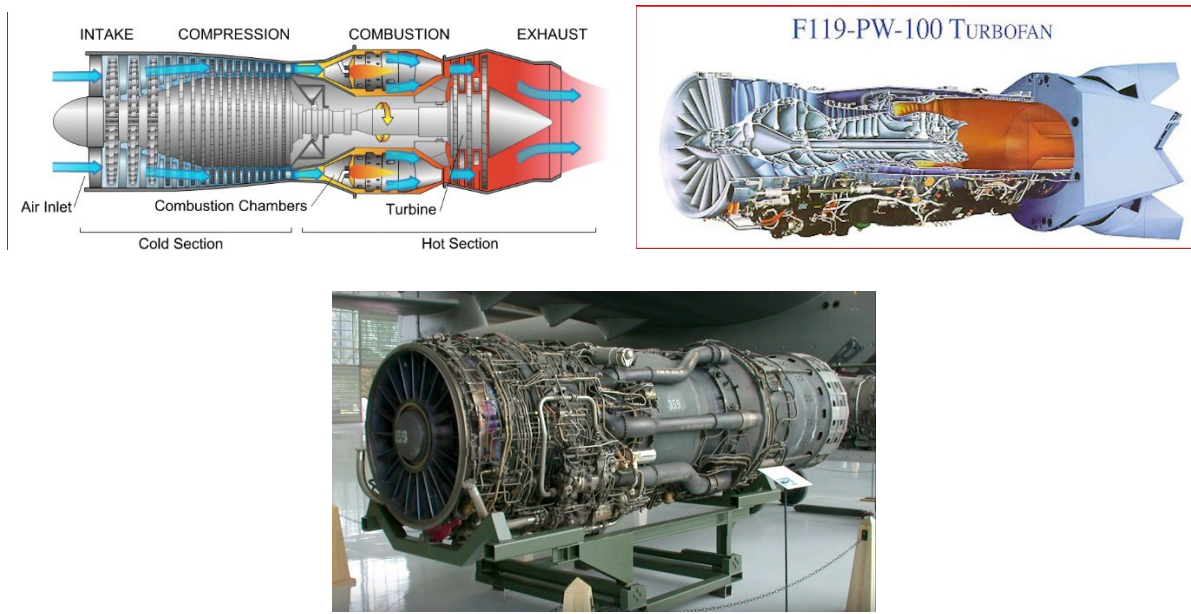

Figure 8. Turbofan jet engine.



Figure 9. Nuclear-powered aircraft Project Convair B72, Weapon System WS 125.

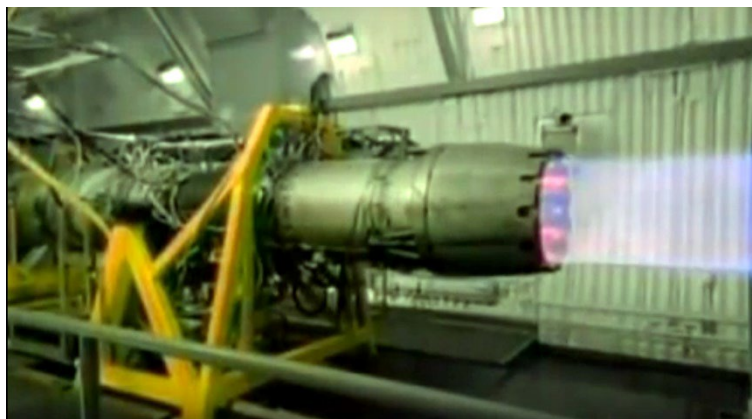
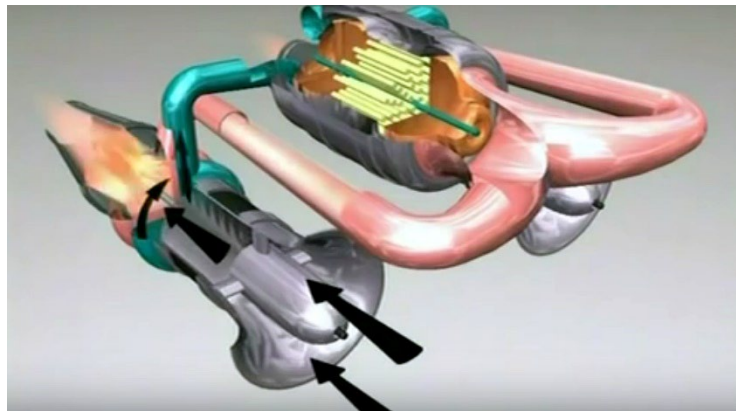

Figure 10. General Electric GE Open cycle nuclear aircraft engine.



Figure 11. Pratt & Whitney closed cycle nuclear aircraft engine using liquid metal as a heat transfer medium.



Figure 12. Russian Tupolev T95 flew with a combination nuclear open cycle engine and conventional engines with shadow radiation shielding of the crew.



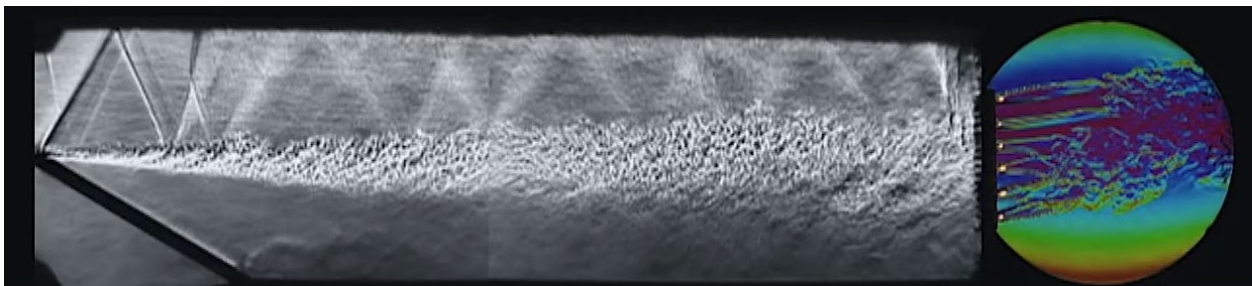
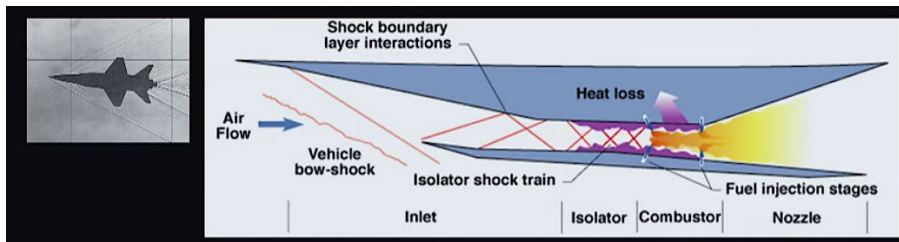
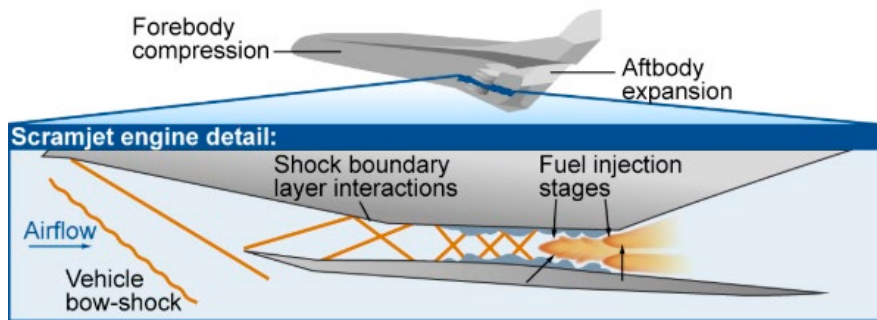
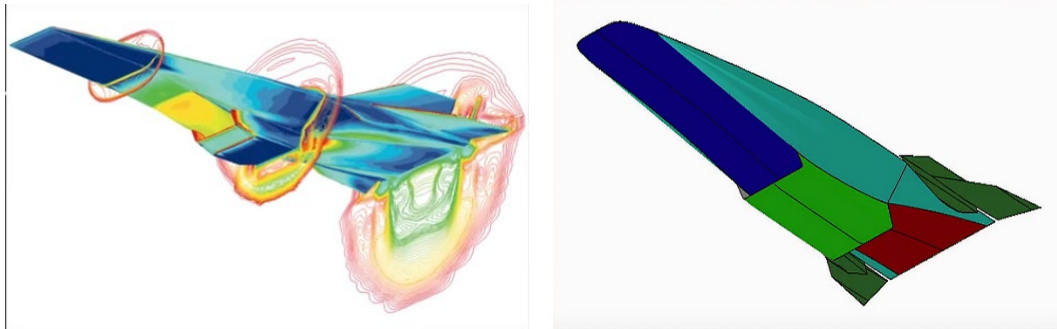

Figure 13. Supersonic Combustion Ramjet (SCRAMJET) engine.

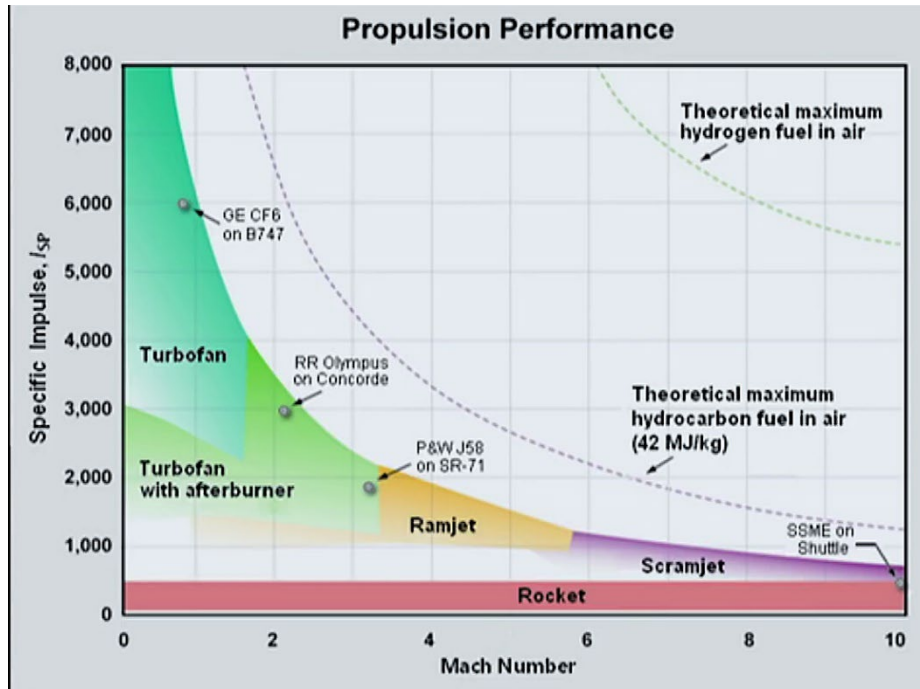

Figure 14. Specific impulse versus Mach number. Air breathing engines are more fuel efficient than rocket engines, allowing sustained hypersonic flight. Space Shuttle Main Engine (SSME): Rocketdyne LOx/LH₂ rocket engine; only high-pressure closed-cycle reusable cryogenic rocket engine ever flown. Source: Boeing.



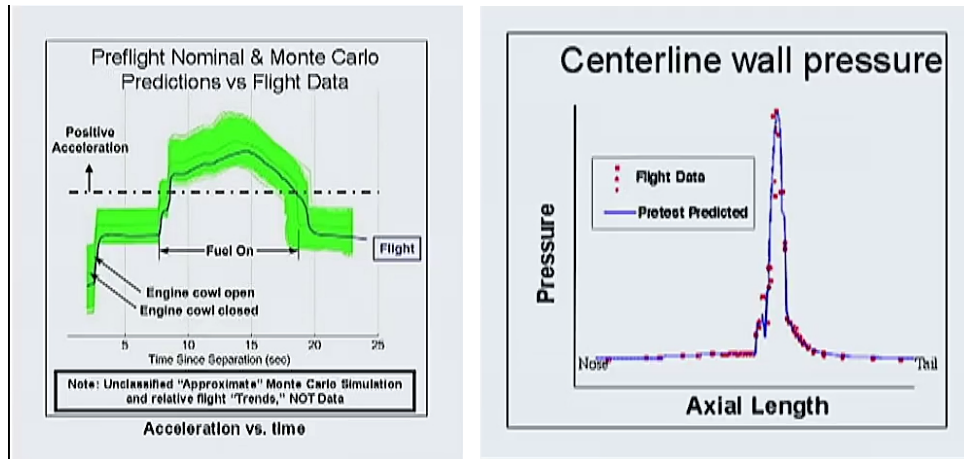

Figure 15. NASA 43A used hydrogen fuel, and reached Mach 6.83 and 9.68 in 2004. Source: NASA.



Figure 16. X51-A Wave Rider hydrocarbon jet fuel scramjet test flight launched from B52, May 1st, 2013. Used a booster rocket to accelerate it from Mach 0.8 to Mach 4.8. Edwards Air Force Base. The missile cleanly separates from the aircraft and successfully demonstrates the full release sequence, including GPS acquisition, umbilical disconnect and power transfer from the aircraft to the missile. The missile also demonstrates fin operation and de-confliction maneuvers which ensures a safe operation for the aircrew. Source: USAF.



Figure 17. Tomahawk Block IV cruise missile launchable from aircraft, ships or submarines.. It uses sophisticated terrain following and scene-matching electronics plus GPS. The “scenes” are assembled ahead of time and programmed into the computer memory of the Tomahawk. The flight path is predetermined and the scene matching provides the final guidance.







Figure 18. X43-B hypersonic scramjet launch from a B-52 bomber aircraft and solid fuel rocket, Mach 7 speed, March 2004. Carbon/carbon light weight composite material can withstand 3,000 degrees Fahrenheit temperatures. Source: NASA. (Mach 10 = 7,000 mph = 12,000 kph).



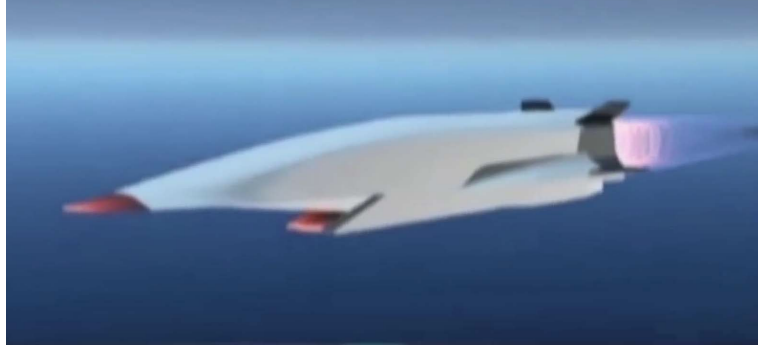

Figure 19. Rocket-launched Waverider Boeing X51A scramjet, 2010.

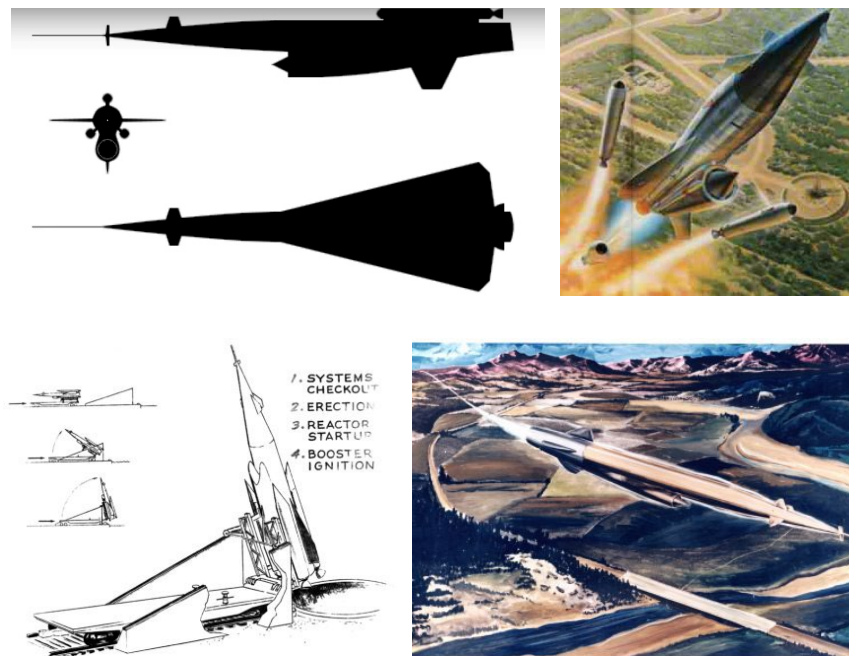

Figure 20. Supersonic Low Altitude Missile (SLAM).

A subsidiary of General Dynamics, Convair at San Diego, California envisioned it as an air-breathing, unshielded nuclear reactor-powered cruise missile that would penetrate enemy airspace at low altitude, drop nuclear payloads on enemy targets, and make a suicidal plunge into a final target.





Figure 21. Convair General Dynamics Pluto 2 nuclear ramjet was conceived to reach a Mach 3.5 speed. Reactor is situated in the back, the payload in the middle and the control and guidance system in front.



Figure 22. Pluto 2 launch using booster rockets.

Launched by single-stage booster rockets the nuclear-powered ramjet engine would kick in once the missile reached sufficient speed. The cruise missile could then loiter for days at an altitude of 1,000 feet or less at a Mach 3.5 speed. It could carry a single large yield thermonuclear warhead or up to 26 multiple smaller devices.

HYPERSONIC STEALTH, RAMJET AND SCRAMJET

Speed is the new stealth. A hypersonic weapon is a missile that travels at Mach 5 or higher, which is about 1 mile per second. Commercial airliners fly at subsonic speed below Mach 1, whereas modern supersonic fighter jets can travel at Mach 2 - 4.

A traditional turbo-jet engine could operate at up to Mach 3 – 4, but traveling faster would need a completely different design to unclutter the flow path and sustain combustion of the supersonic airflow inside the engine using a Supersonic Combustion Ramjet “SCRAMJET”, which can operate between Mach 5 - 15.

To maintain sustained hypersonic flight, a vehicle must endure the extreme temperatures of flying at such speeds. The faster a vehicle flies, the pressure and temperature rise exponentially needing materials that can withstand high temperatures over a long period of time.

Two types of approaches emerged: hypersonic cruise missiles and hypersonic glide vehicles:

1. Hypersonic cruise missiles are powered all the way to their targets using a SCRAMJET. It takes 6 minutes from the time they are launched until the time they reach their target. They can fly at altitudes up to 100,000 feet whereas hypersonic glide vehicles can fly above 100,000 feet.
2. Hypersonic glide vehicles are placed on top of rockets, launched, and then glide on top of the atmosphere like a plane with no engine on it. They use aerodynamic forces to maintain stability to fly along and to maneuver. Because they are maneuverable they can keep their target as a secret up until the last few seconds of their flight.

NUCLEAR REACTOR DESIGN FOR SLAM, SUPERSONIC LOW ALTITUDE MISSILE

The reactor development work for nuclear propulsion systems was started by the NEPA Project and specific development for nuclear ramjet application at the Aircraft Nuclear Propulsion Department of the General Electric Company.

As the ramjet program gained in importance, it was moved to the Lawrence Radiation Laboratory (LRL) of the University of California in January 1957. The LRL's worked with the Chance Vought Company in determining the reactor propulsion requirements.

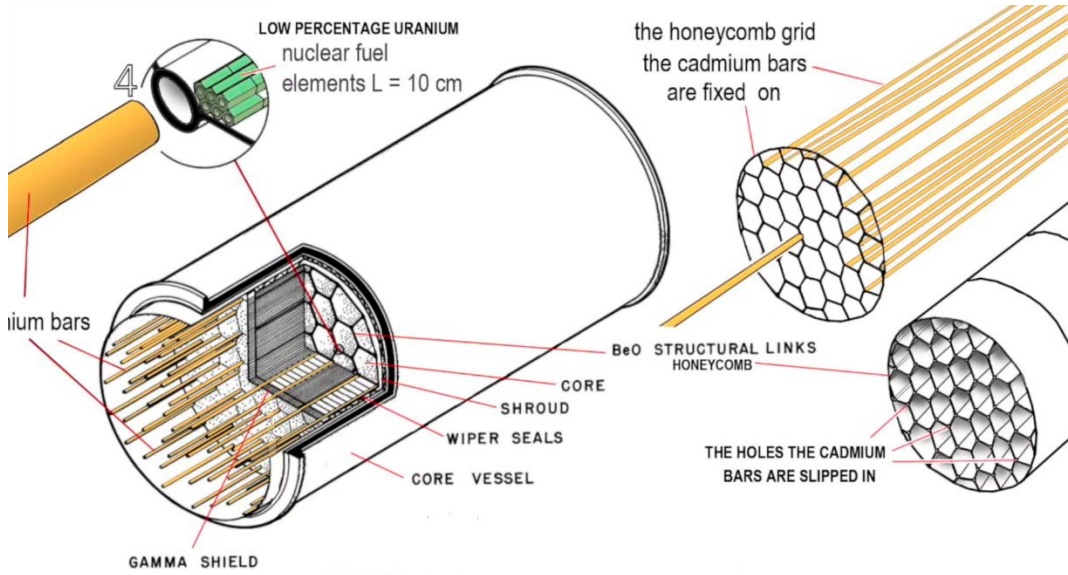
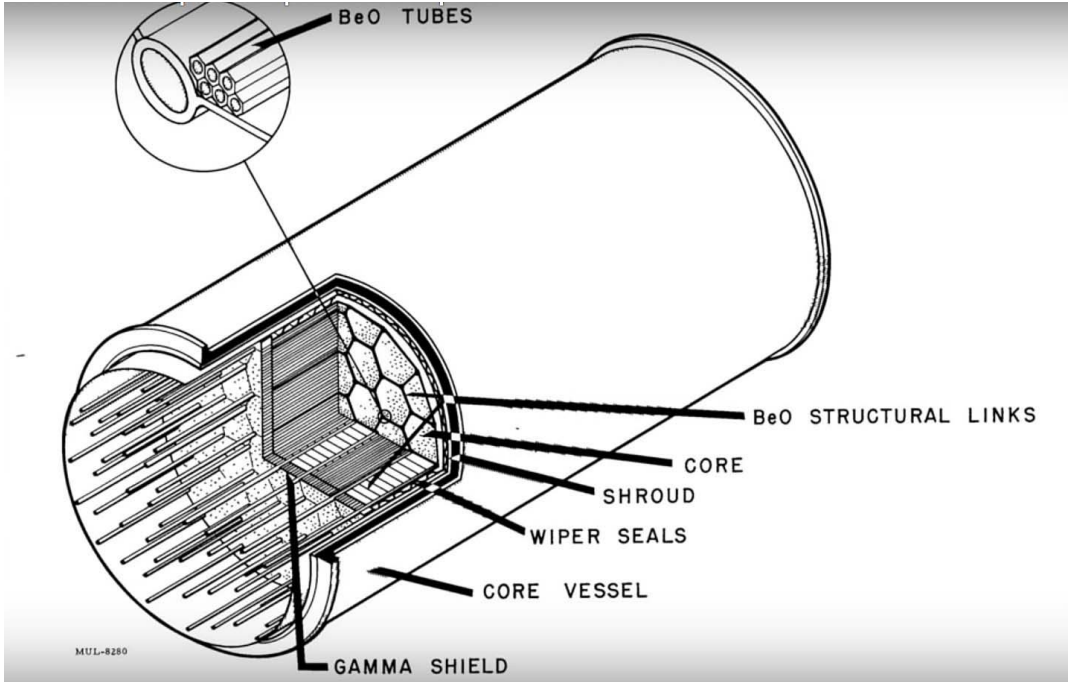

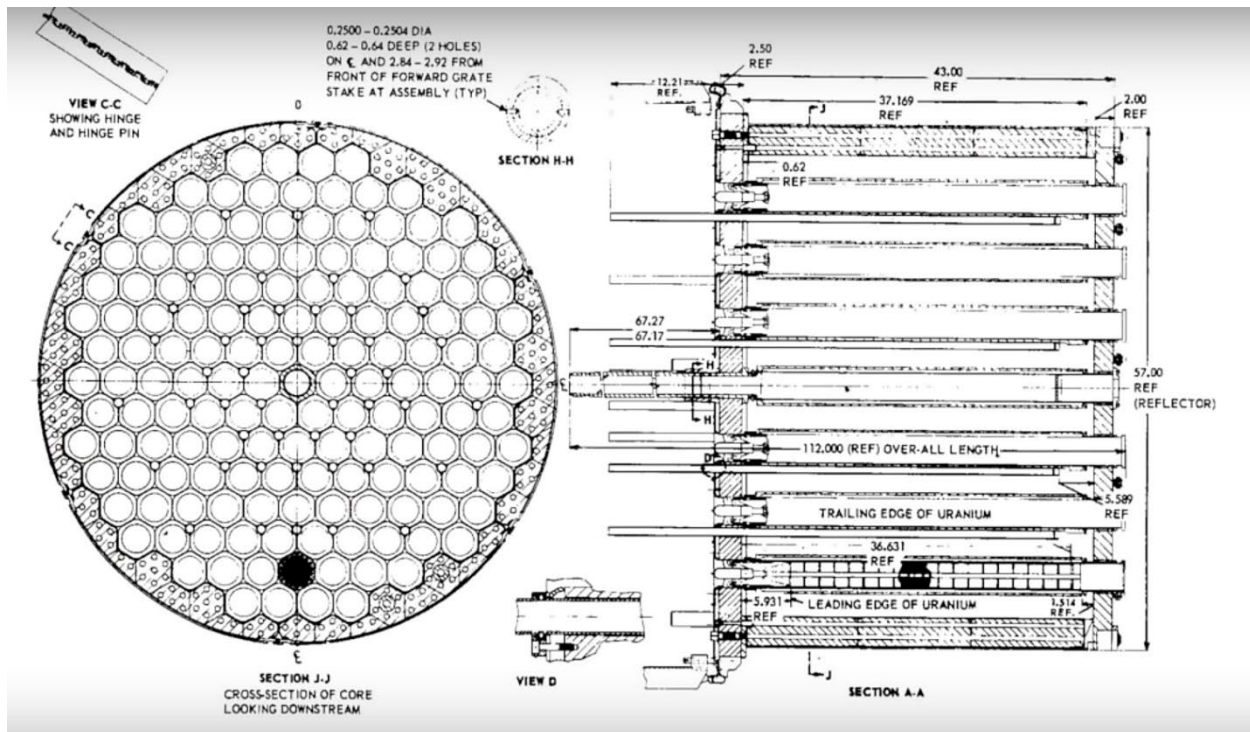

Figure 23. Nuclear reactor configuration for SLAM. HTRE 3 core assembly.

Table 1. Nuclear reactor characteristics for the SLAM reactor system.

Diameter	57.25 in
Fissionable Core	47.24 in
Length	64.24 in
Core Length	50.70 in
Critical Mass of Uranium	59.90 kg
Average Power Density	10 MWth / ft ³
Total Power	600 MWth
Diameter	57.25 in
Average fuel element Temperature	2,330 °F

The fuel elements for the test reactors were made of the high-temperature ceramic beryllium oxide (BeO). This was mixed with enriched uranium dioxide (UO₂) in a homogeneous mixture with a small amount of zirconium dioxide (ZrO₂) for stabilization. This mixture in a plastic mass was extruded by the Coors Porcelain Company under high pressure and then sintered to near theoretical minimum density.

Each fuel element was a hollow hexagonal tube approximately 4 inches long, 0.3 inches across flats, and had an inside diameter of 0.227 inches. These were stacked end to end to provide the 50.7 inch length of heated air passage. There were 27,000 of these heated airflow channels and 465,000 individual fuel elements. The design with these small unattached pieces was such that the problems of thermal stress in ceramics was minimized.

Two reactor tests were conducted to verify the feasibility of the project. The Tory II-A was a scaled-down test which was conducted in mid-1961 and operated at design conditions on October 5, 1961. The Tory II-C was a full-scale reactor test for a period of 292 seconds which was the limit of the air supply from the storage facility. That facility stored 1.2 million pounds of air which had to be preheated to 943 degrees Fahrenheit and supplied at a pressure of 316 psi to simulate ramjet inlet diffuser conditions. Tests were conducted at the Jackass Flats area in The Nevada Test Station by the Lawrence Radiation Laboratory. These tests demonstrated the feasibility of the nuclear power plant for the SLAM system.

RADIATION EFFECTS

The source of energy for SLAM propulsion was to be a nuclear fission reactor operating at a power level of 600 MWth. To minimize its weight, the reactor was not to have radiation shielding for the fission products of neutrons and gamma rays. As a result, the neutron flux was calculated to vary from $9 \times 10^{17} \text{ n / (cm}^2\text{.sec)}$ in the aft section to $7 \times 10^{14} \text{ n / (cm}^2\text{.sec)}$ in the nose section. Gamma ray energy was expected to be $4 \times 10^{11} \text{ MeV}$ in the aft section and $1.2 \times 10^8 \text{ MeV}$ in the electronics compartment.

This requires careful selection of materials which could survive not only the high temperatures but also the high radiation levels. Some very sensitive components required a feasible amount of local shielding. The result of the investigations led to the conclusion that missile subsystems were available or could be made available for the SLAM application. Flight testing of the missile was planned to be conducted over the northwest Pacific Ocean with termination in deep ocean waters in the neighborhood where atmospheric testing of nuclear weapons had taken place at that time period.

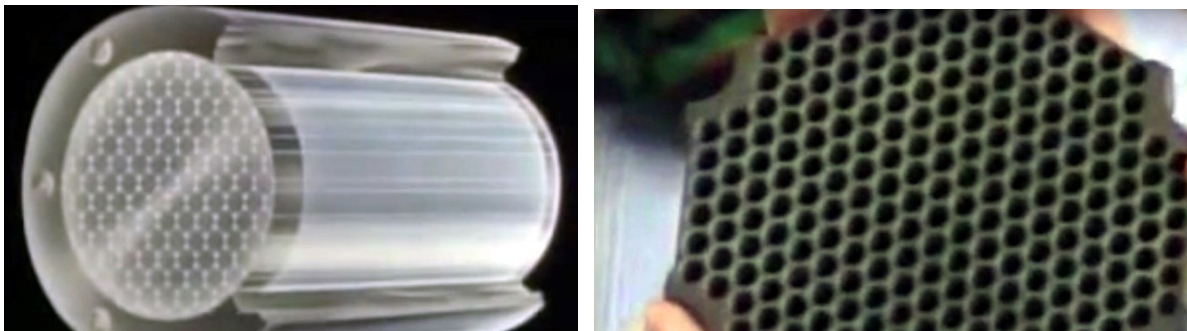

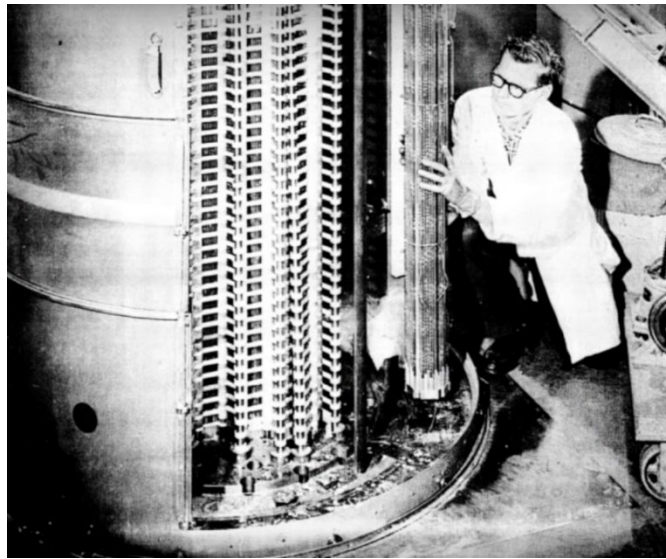
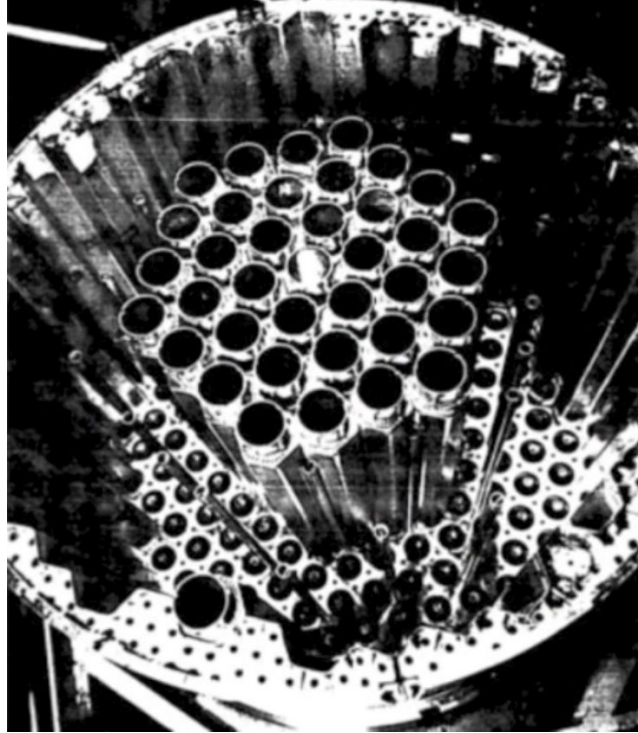

Figure 24. Reactor configuration using a hexagonal BeO moderator configuration.

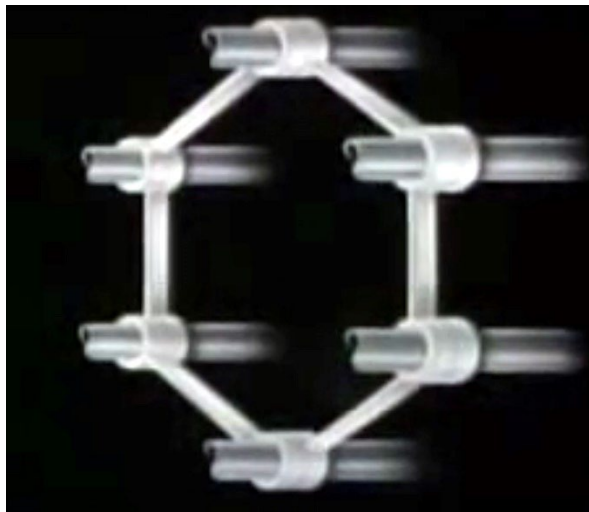
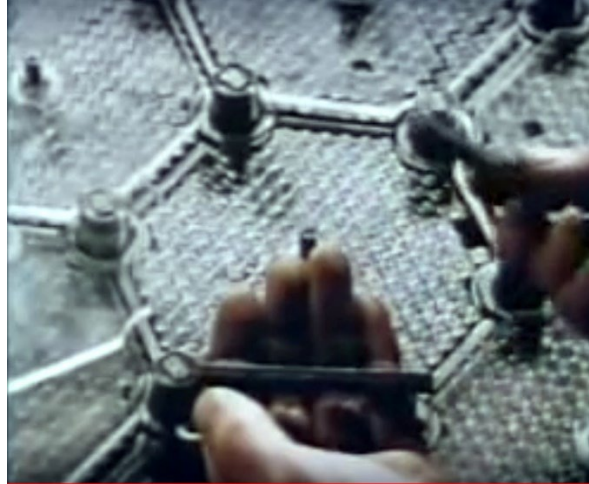

Figure 25. Tubular fuel elements connected with tie rods. The generated pressures required the use of tie rods.

SLAM AIRFRAME TESTING

The airframe had been designed to operate in the environment of Mach 3 at sea level where skin temperatures reach 1,000 Fahrenheit and the sound pressure level is on the order of 162 db. The aerodynamics in this flight regime was little explored. Almost 1,600 hours of wind tunnel testing in the national laboratories resulted in a canard configuration design that could operate in the planned flight profile.

The classical spike inlet of a ramjet was replaced with a scoop-type inlet, which gave a pitch/yaw performance over a wider range and a pressure recovery of 86 percent that was much higher than the initial program objective.

An extensive materials investigative program resulted in the selection and fabrication of a section of fuselage using Rene 41 stainless steel with a skin thickness of 1/10 to 1/4 inch. This was strength-tested in a furnace to simulate aerodynamic heating. Forward sections of the missile were

to be gold plated to dissipate heat by radiation. A 1/3-scale model of the missile nose, inlet and duct was constructed and wind tunnel tested.

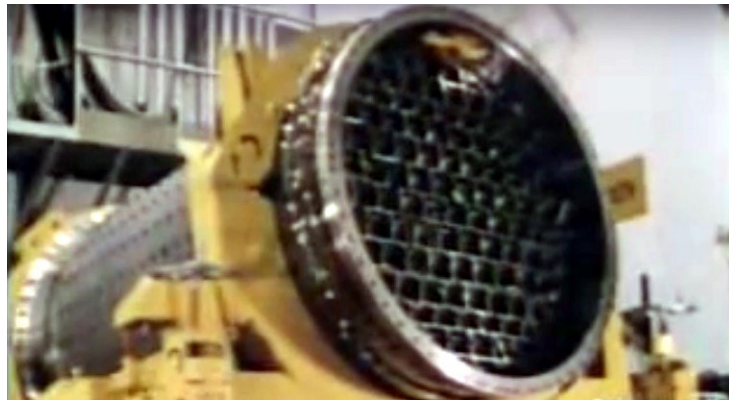

Figure 26. Torre IIC air-cooled reactor core consisted of a hexagonal lattice containing cylindrical fuel elements.



Figure 27. Torre IIC attached to exhaust nozzle.

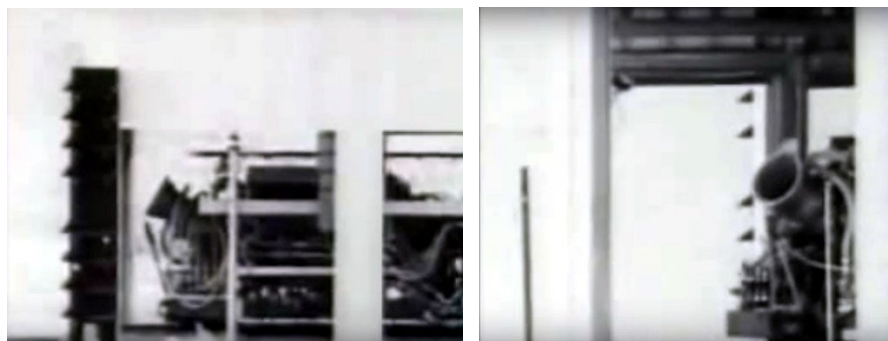

Figure 28. Testing of nuclear ramjet engine.

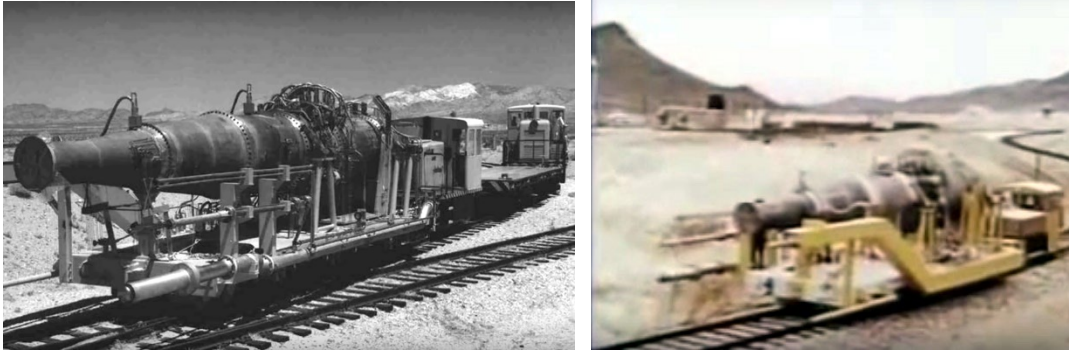

Figure 29. Torre IIC on way to testing.



Figure 30. Tore IIC after testing.

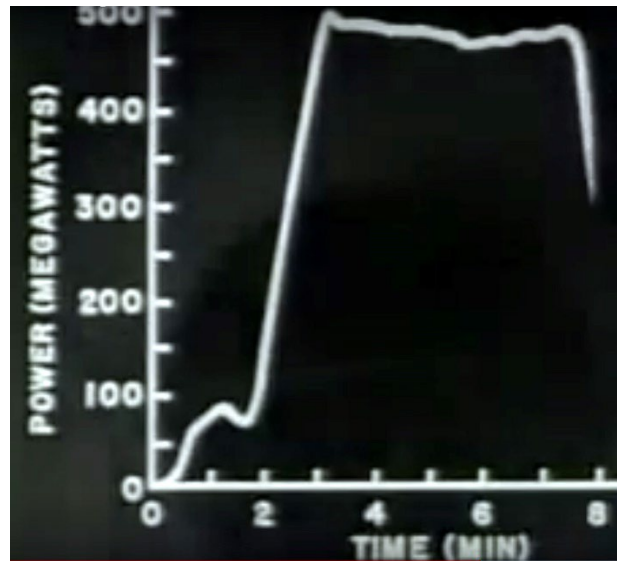
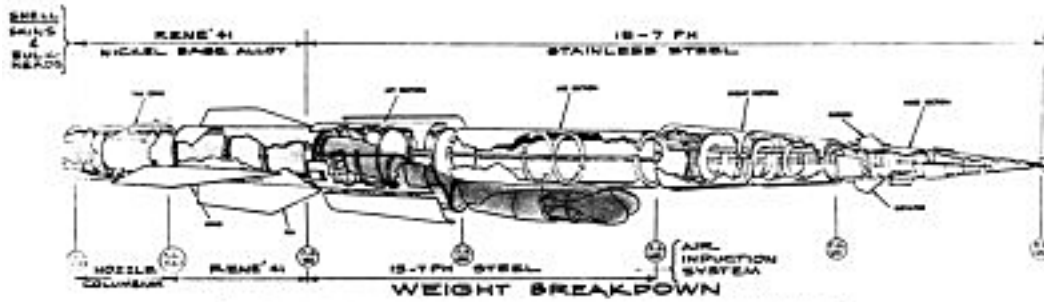

Figure 31. Reactor was tested at a power level of 500 MWth for 5 minutes.



COMPONENTS	WEIGHT (lbs)
<u>SURFACES</u>	(2710)
WINGS	1672
FIN	670
CONTROL SURFACES	368
<u>FUSELAGE</u>	(9195)
NOSE SECTION	491
FRONT SECTION	1071
MID SECTION	3349
AFT SECTION	3516
TAIL CONE	768
<u>POWER PLANT</u>	(22454)
REACTOR & SHELL	12867
AIR INDUCTION SYSTEM	4016
SHIELDING	4954
CONTROLS	617
<u>EQUIPMENT</u>	(6149)
<u>WARHEAD</u>	(8640)
FLIGHT GROSS WEIGHT	49148
BOOSTER WEIGHT	54401
LAUNCH WEIGHT	103549

Figure 32. SLAM missile technical components weights.



Figure 34. SLAM configurations.

THE “BUREVESTNIK” NUCLEAR-POWERED CRUISE MISSILE

This is claimed to have a virtually unlimited range probably using a ramjet engine powered by a nuclear reactor. A possible 9M730 project, the device, once launched, heats up the inlet shocked-air, which is mostly nitrogen gas, and does not require any more fuel, hence claims an unlimited range: “Russia has completed the trials of miniaturized nuclear power units for cruise missiles of unlimited range and for autonomous submersibles of an oceanic multi-purpose system.” "Russia has created a small-size super-powerful power plant that can be placed inside the hull of a cruise missile and guarantee a range of flight ten times greater than that of other missiles." "A low-flying low-visibility cruise missile armed with a nuclear warhead and possessing a practically unlimited range, unpredictable flight path and the capability to impregnate practically all interception lines is invulnerable to all existing and future missile and air defenses". To date, those technologies have been designed and are in the testing phase by Russia.

Its main characteristics are:

- i) Low-flying and steady,
- ii) Nuclear powered,
- iii) Unlimited flight range,
- iv) Can penetrate missile and air defense shields,
- v) Unpredictable flight path.





Figure 35. Nuclear-powered earth-hugging, radar-evading cruise missile which is claimed to have a virtually unlimited range probably using a ramjet engine powered by a miniature nuclear reactor. This missile can take an arbitrary path to its target and circumvent enemy defenses. The advantage to being nuclear-powered is that it can loiter around for a long time, due to its almost practically limitless energy supply. The missile has special compartments where air is heated by a nuclear reactor to several thousand degrees, then thrust is created by ejecting the superheated air. The Russian photographs suggest that four rear nozzles are creating the thrust for the missile. The most successful test was in November 2017, the Skyfall missile flew little more than twenty miles before crashing into the sea. The nuclear refueling ship Serebryanka, which was also present at the accident in August 8, 2019 was dispatched to recover the possibly irradiated debris.

NUCLEAR ROCKET BUREVESTNIK TEST ACCIDENT AT NYONOKSA TEST RANGE, AUGUST 8, 2019

An explosion occurred in a test thought to be linked to the 9M730 Burevestnik, meaning "petrel", a type of seabird. Russian President Vladimir Putin described the missile in a speech to the Russian parliament on March 1st, 2018. The NATO organization has given it the designation SSC-X-9 Skyfall.

On August, 15, 2019, the Russian newspaper Izvestia said authorities had been testing an advanced booster device featuring a liquid propellant rocket engine mounted with "nuclear batteries." It also denied the explosion was tied to Putin's nuclear-powered cruise missile. The test may be tied to a new propulsion technology that uses nuclear batteries, which would heat up some chemical like hydrogen to provide thrust. The explosion would be then a possible hydrogen explosion.

The Russian claim that a "liquid-fuel" booster was being tested may be true. The most likely scheme for a nuclear-powered missile involves a ramjet engine, in which the reactor would heat onrushing air at speeds exceeding twice the speed of sound. This expanding heated air would be squeezed out the engine's rear nozzle, resulting in sustainable supersonic propulsion. However, a conventional booster would be required for the missile to move fast enough for the ramjet to work. It is possible that scientists were testing the robustness of the missile's reactor when exposed to the heat and physical stress caused by the rocket boosters.

Initially the Russian defense ministry claimed that the explosion only involved a liquid-fuel rocket engine, and gave the death toll as two, without specifying the victims. Later Rosatom said the test had involved a "radio-isotope propellant source," an "isotope-fuel" engine, and had taken place on an offshore platform. The engineers had completed testing, but suddenly a fire broke out and the engine exploded, throwing the men into the sea.

Western intelligence had been keeping tabs on Skyfall prior to Putin's speech. About a dozen tests have been held since 2016, first at Kapustin Yar near Volgograd, then the Pan'kovo test site on Yuzhny island. Two tests were successful. Pentagon snooping of the latter by WC-135 weather reconnaissance planes used to measure radiation may have led to the program's relocation to Nyonoksa, which is distant from international airspace.

In the most successful test in November 2017, which can be seen in a video released by Putin, the Skyfall missile flew little more than twenty miles before crashing into the sea. The nuclear refueling ship Serebryanka, which was also present at the accident in August 8, was dispatched to recover the possibly irradiated debris.

Five Russian nuclear experts were the victims of the rocket engine explosion in Sarov, a closed town 373 km (232 miles) east of Moscow, where nuclear warheads are manufactured: Alexei Vyushin, a designer and software specialist; Yevgeny Korotayev, a senior electrical engineer; Vyacheslav Lipshev, head of the scientific testing team; Sergei Pichugin, testing engineer; Vladislav Yanovsky, deputy head of the scientific testing department. Two military personnel also died in the accident. Six people were injured in the accident, possibly by radiation dose sickness or contamination.

The Russian state nuclear agency, Rosatom, later said the experts had been testing a nuclear-powered engine. The test was on an offshore platform in the Arctic, at a naval test range. Three other engineers were injured in the blast, and treated in a hospital.

The explosion was followed by a 40-minute radiation spike in Severodvinsk, a city 40 km or 25 miles east of the Nyonoksa test range, by the White Sea, suggesting a criticality accident. Severodvinsk officials said radiation in the city reached 2 microsieverts per hour, then fell back to the normal 0.11 microsieverts per hour with both levels too small to cause radiation sickness.

Nuclear propulsion poses technical challenges in the speed versus the weight of the system, and the risk of radioactive exhaust. The Nyonoksa explosion could have involved a different weapon, equally capable of delivering a nuclear warhead: a new long-range, anti-ship cruise missile called Zircon, which is hypersonic and can fly at up to eight times the speed of sound, or a new long-range underwater drone, launched from a submarine, called Poseidon

Ahead of the test, the defense ministry imposed an exclusion zone in Dvina Bay; the waters north of the Nyonoksa test range. A Norwegian Arctic news website, the Barents Observer, reported that a Russian specialized nuclear cargo ship, the Serebryanka, was inside the exclusion zone on August 9, 2019.

A lot of skepticism exists about whether the Burevestnik will ever see the light of day as another state-of-the-art Russian missile, the Bulava, had many years of failed tests. The Zircon and Poseidon missiles are more advanced projects. The Poseidon underwater drone already evolved into prototype form. Poseidon, like the Burevestnik, appears to be an "apocalyptic" weapon, impractical for anything short of all-out nuclear war.

Russia's government newspaper Rossiiskaya Gazeta in July 2019 described Burevestnik as a vengeance weapon. That was also the designation used by Germany to describe its V-rockets attacks on the UK late in World War II. The Burevestnik, capable of long-duration flight and avoiding air defenses, would target any remaining vital infrastructure after Russia's intercontinental ballistic missiles had already struck enemy territory.

Readings for gamma radiation at six testing stations in Severodvinsk, a city of 180,000 people, ranged from 4 to 16 times the normal rate of 0.11 microsieverts per hour. A reading of 1.78 microsieverts per hour was detected at one station, well above normal but below dangerous levels.

The explosion sparked panic among locals, with some rushing to buy medical iodine, which can limit the effects of radiation on the thyroid gland. Pharmacies' stocks of iodine run out in the cities of Arkhangelsk and Severodvinsk.

President Vladimir Putin said the test involved a new weapon system. A tweet by USA President Donald Trump suggested Russia was indeed testing such a missile system, saying the USA was "learning much" from the explosion. In the tweet, posted on Monday, August 12, 2019 he wrote that the USA was developing "similar, though more advanced, technology" than the Russians.

Russian medics who treated the radiation sickness victims had no protection and fear they were irradiated themselves. At least 90 people came into contact with the casualties, but the military did not warn them of any nuclear contamination risk. The medics were at the civilian Arkhangelsk regional hospital, which treated three of the injured, while three other casualties were taken to an Arkhangelsk hospital called Semashko, which is equipped for radiation emergencies. The radiation picture developed by the hour. Blood tests were done, and every hour this or that cell count was plunging which imply a high radiation dose equivalent. The next day the three

victims were transferred to a hospital in Moscow which has radiation specialists. A military team later carried out decontamination work in the Arkhangelsk hospital.

Two weeks after the explosion the Russian health ministry said none of the medics at the Arkhangelsk hospitals had received a hazardous radiation dose. Its conclusion was based on medical examination of 91 staff.

On Monday August 12, 2019, the Comprehensive Nuclear Test-Ban Treaty Organization (CTBTO) international nuclear agency reported that the two Russian radiation monitoring stations nearest to Nyonoksa had gone offline soon after the explosion. The revelation fueled suspicions that the radiation could have been heavier than officially reported. The Comprehensive Nuclear Test-Ban Treaty Organization (CTBTO) said the technical failure at those sites was then followed by a failure at two more. Russia said the weapons test was none of the CTBTO's business, and added that handing over radiation data was voluntary. Two of the monitoring stations resumed functioning again.

KINZHAL, “DAGGER” HYPERSONIC CRUISE MISSILE

The Kinzhal “Dagger” air-launched, precision-guided cruise missile is designed to engage ground-based and seaborne targets. The air-to-ground missile code-named Kh-47M2 is launched from a modified MiG-31BM supersonic interceptor aircraft. It is based on the 9M723-1F variant of the 9M723-1 missile as used by the 9K720 Iskander-M short-range road-mobile ballistic missile system. It uses a solid propellant motor with a non-separating warhead and a finned truncated tail-cone at the missile’s rear to decrease the aerodynamic effects of the missile when carried at high-speed on the aircraft and protects both its control components and motor nozzle from damage when in transit.

No extraneous external components are located on its surface other than its two cable ducts, which run from the control/motor nozzle section, over the motor and into to the guidance section, and the skin of the missile has been covered with a special heat-resistant and radar absorbing coating to minimize the heat effects on it and further lower its Radar Cross Section (RCS) [1].





Figure 36. High precision Kinzhal “Dagger,” hypersonic cruise missile launched from the belly of a Mikoyan Mig 31 Foxhound supersonic interceptor jet.



Figure 37. Kinzhal, “Dagger” cruise missile launch from Mig 31BM interceptor has a range of 1,000 kms.



Figure 38. Kinzhal Dagger hypersonic cruise missile in flight.

HYPERSONIC COMMERCIAL AND MILITARY AIRCRAFT, THERMAL BARRIER

As a gas flows at a high speed, its kinetic energy is converted into heat energy according to the conservation of energy as:

$$\frac{1}{2}mv^2 = \frac{3}{2}kT,$$

hence its temperature increases proportional to the square of the speed as:

$$T = \frac{1}{3} \frac{m}{k} v^2$$

This heats the front of the supersonic aircraft at the stagnation point.





Figure 39. Black Bird, SR 71 spy plane reached Mach 3.6 challenging the “Thermal Barrier” with its titanium instead of Aluminum structure. The SR 71 had to allow for the thermal expansion of its fuel tanks in a preliminary flight allowing for fuel leakage before being refueled ahead of starting its main mission flight.

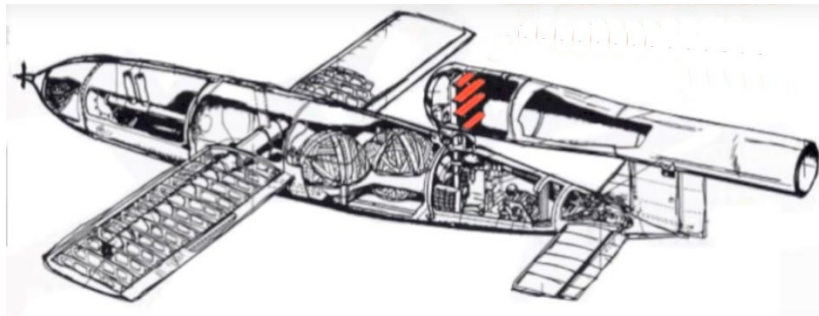

Figure 40. Pulsed engine of subsonic German V1 rocket dissipated heat buildup in stove pipe engine.



Figure 41. Bell X1 first experimental supersonic, Mach 1 = 1,600 km/hr, manned jet.



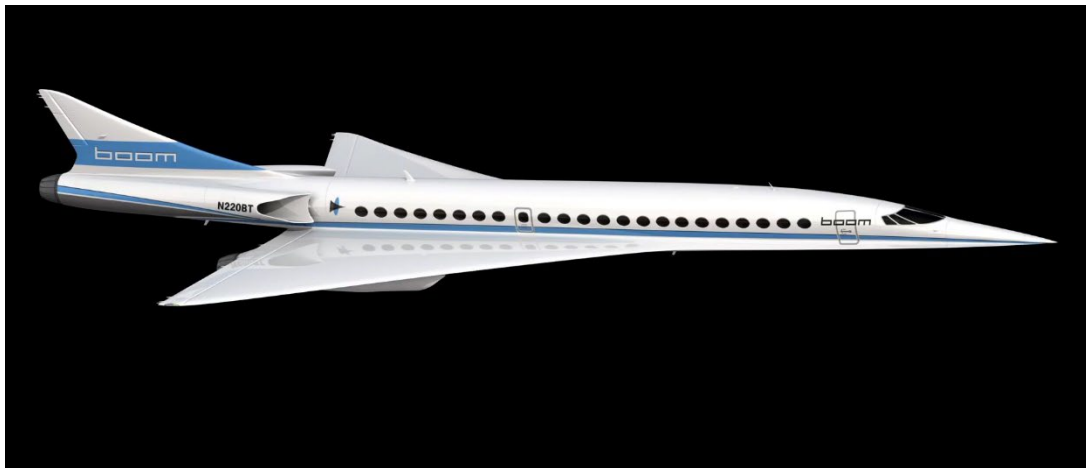

Figure 42. The Concorde (Mach 2) and the Boeing 2707 supersonic designs (Mach 3 and 300 passengers) in the 1960s were abandoned in 2003 but are evolving into the Boom supersonic design for passenger jets. The temperature increase elongated the length of the fuselage in flight by 20 cms. Source: Boom.



Figure 43. Boeing Mach 5 hypersonic jet model. On top, two vortices generate lift. At the bottom, the nacelle includes combined conventional and scramjet engines. Source: Boeing.



Figure 44. Boeing Mach 5, 95,000-foot hypersonic commercial aircraft concept. The speed of sound drops off with altitude, so Mach 5 at 70,000 or 95,000 feet is a much lower speed than a theoretical Mach 5 at sea level. Source: Boeing.

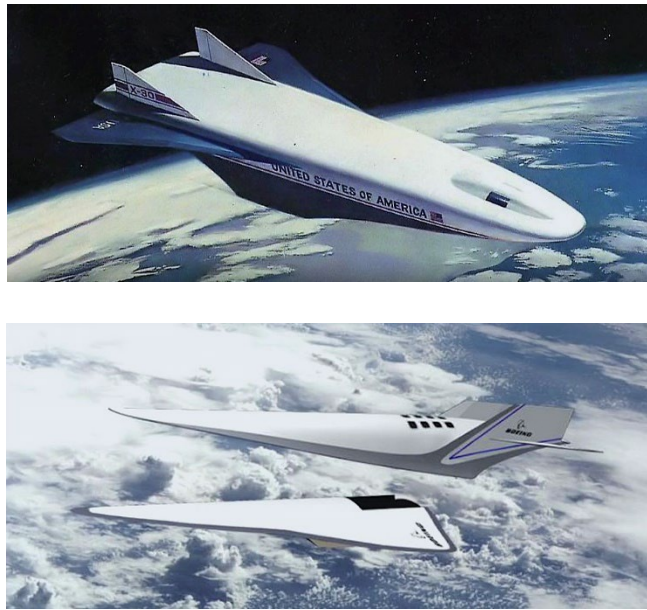

Figure 45. "Orient Express" Space plane concepts. Source: Boeing.



Figure 46. European scramjet propulsion wind tunnel testing model.



Figure 47. French conceptualization of supersonic aircraft.





Figure 48. TR3 B1 and TR3 B1 advanced alleged magneto hydrodynamic propulsion aircraft pictures in flight.

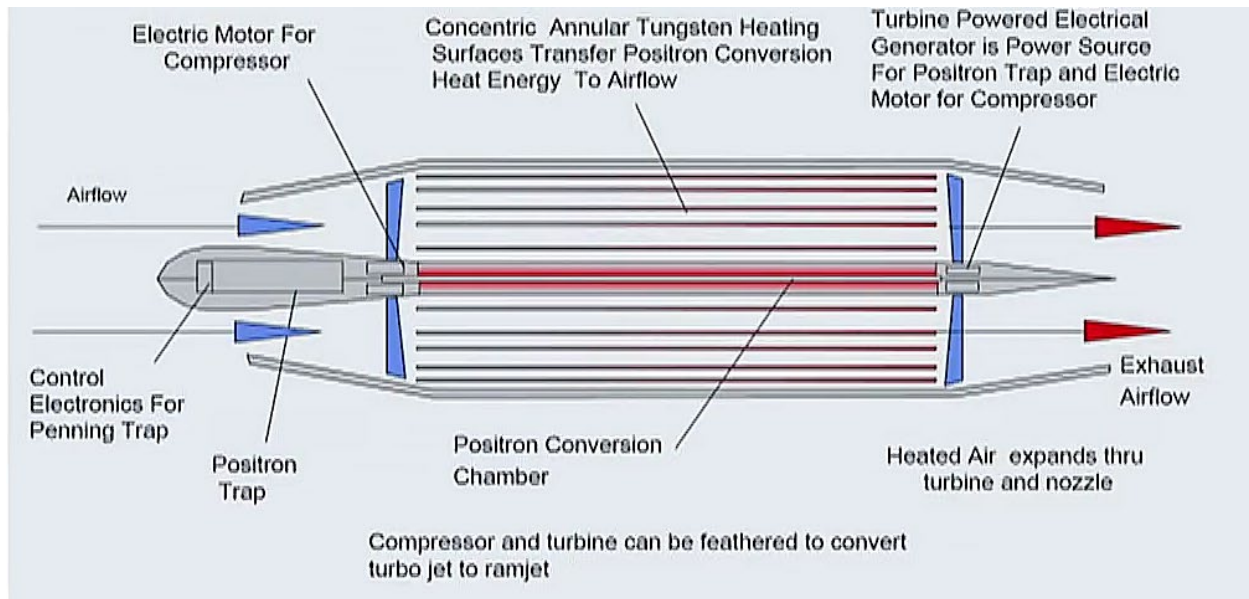
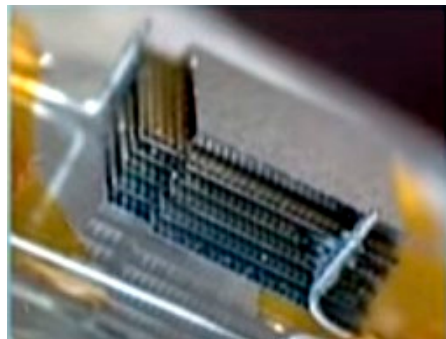
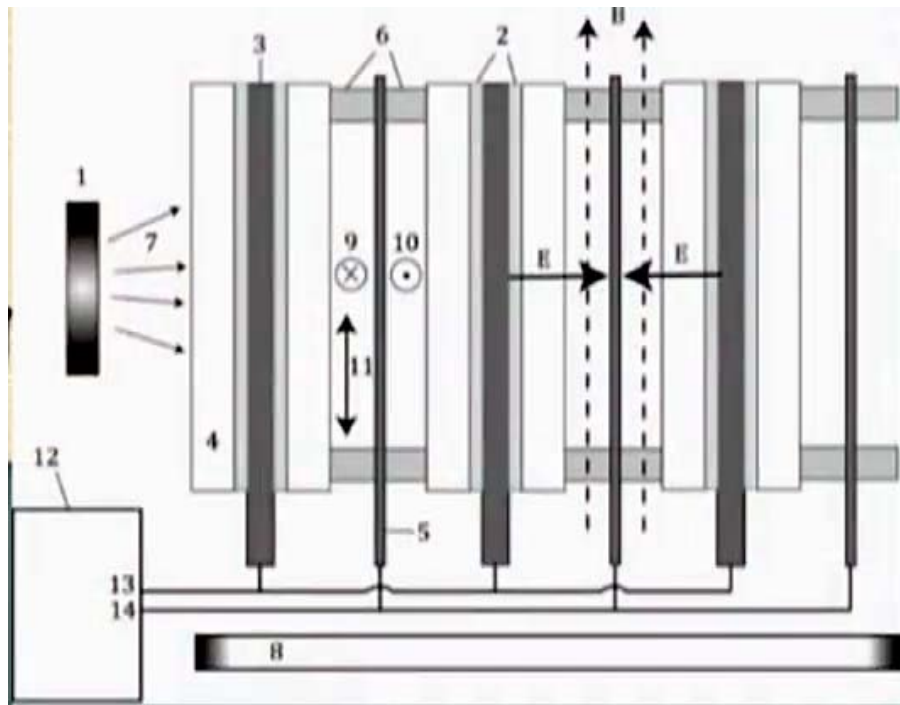

Figure 49. Matter/antimatter positron/electron futuristic space and jet propulsion conceptualization. Source: Positronics.



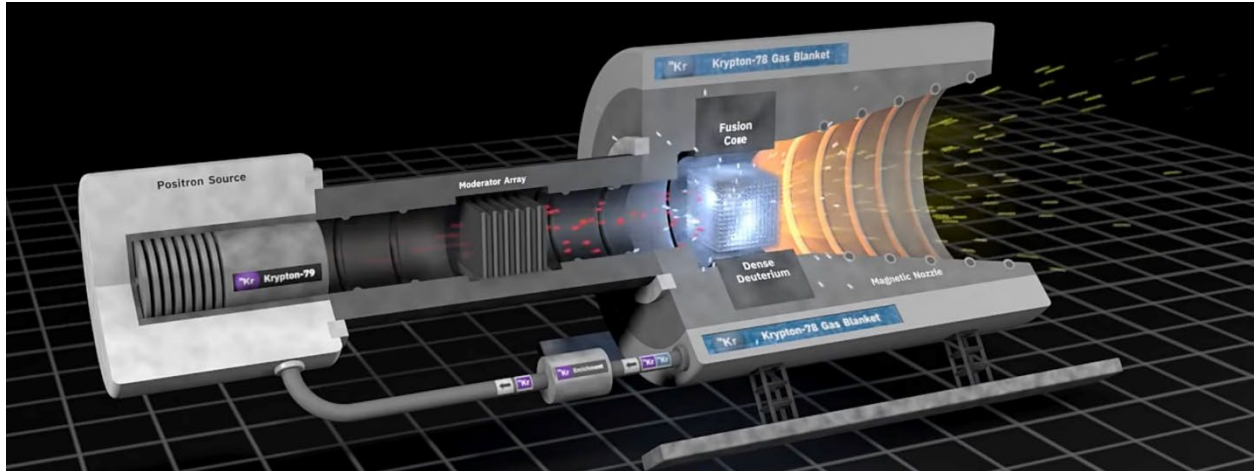

Figure 50. Antimatter from radioisotope source of positrons moderator to cold positrons patent. The annihilation gamma rays are converted to electrons that can be directed into a nozzle by electric and magnetic fields to be used as a thruster. Source: Positronics.

Boeing unveiled the initial concept of a hypersonic aircraft at the American Institute of Aeronautics and Astronautics (AIAA) Aviation 2018 conference in Atlanta, Georgia. The concept depicts a passenger capacity larger than long-range business jets, but much smaller than Boeing's flagship 737, with indications the plane could enter service by the mid/late 2030s.

The hypersonic aircraft could fly at Mach 5 with an altitude ceiling of 95,000 feet. It would travel 2.5 times faster and 30,000 feet higher than the Aérospatiale / BAC Concorde, the British-French turbojet-powered supersonic passenger airliner, which operated from 1976 to 2003.

Boeing touts the ability to operate the aircraft with same-day return flights from the USA to Asia and Europe, which would significantly increase its asset utilization. Boeing determined that Mach 5 (3,836 mph) as the sweet spot between civil and non-transport military applications. The plane can get across the Atlantic in about 2 hours, and across the Pacific in about 3 hours. A fierce race for hypersonic technologies is underway among the global superpowers.



Figure 51. Hermeus is concentrating on earthly hypersonic flight with propulsion technology that could propel the aircraft faster than Mach 5, essentially cutting flight time between New York and London from seven hours to 90 minutes or less.

MANEUVRABILITY

Hypersonic vehicles are hard to control or maneuver. Their maneuver capabilities in practice will be extremely limited. They can barely keep the engines stable and lit when traveling in a straight line at an optimal altitude. To change the Angle of Attack (AoA), heading and altitude would stall it or flame it out, both of which would be unrecoverable.

The USA focused on Mach 5 for stability, control and sustained powered flight, because this is implied by the known physics and the material science of today at a viable weapon price tag.



Figure 52. Lockheed Martin scramjet.



Figure 53. Northrup-Grumman Global Hawk Unmanned Aerial Vehicle UAV a candidate aircraft for nuclear propulsion as it does not need crew shielding. Instrumentation shielding will be required though.

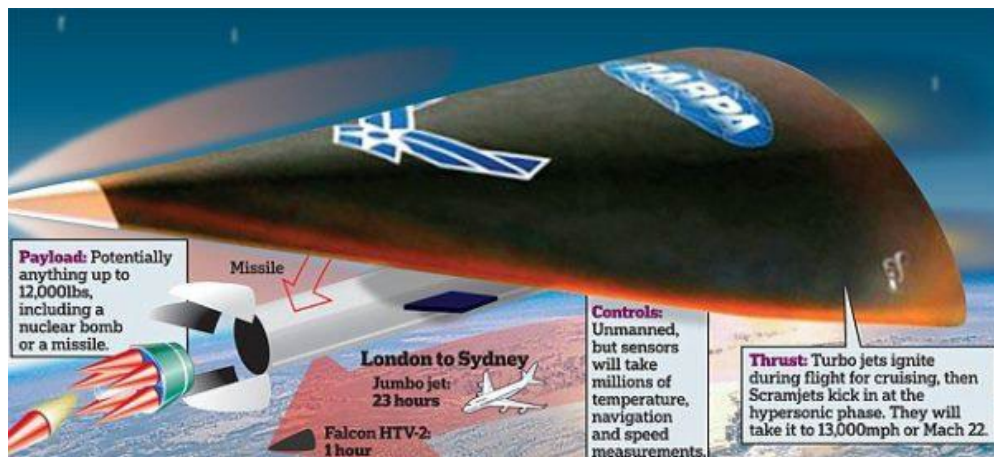
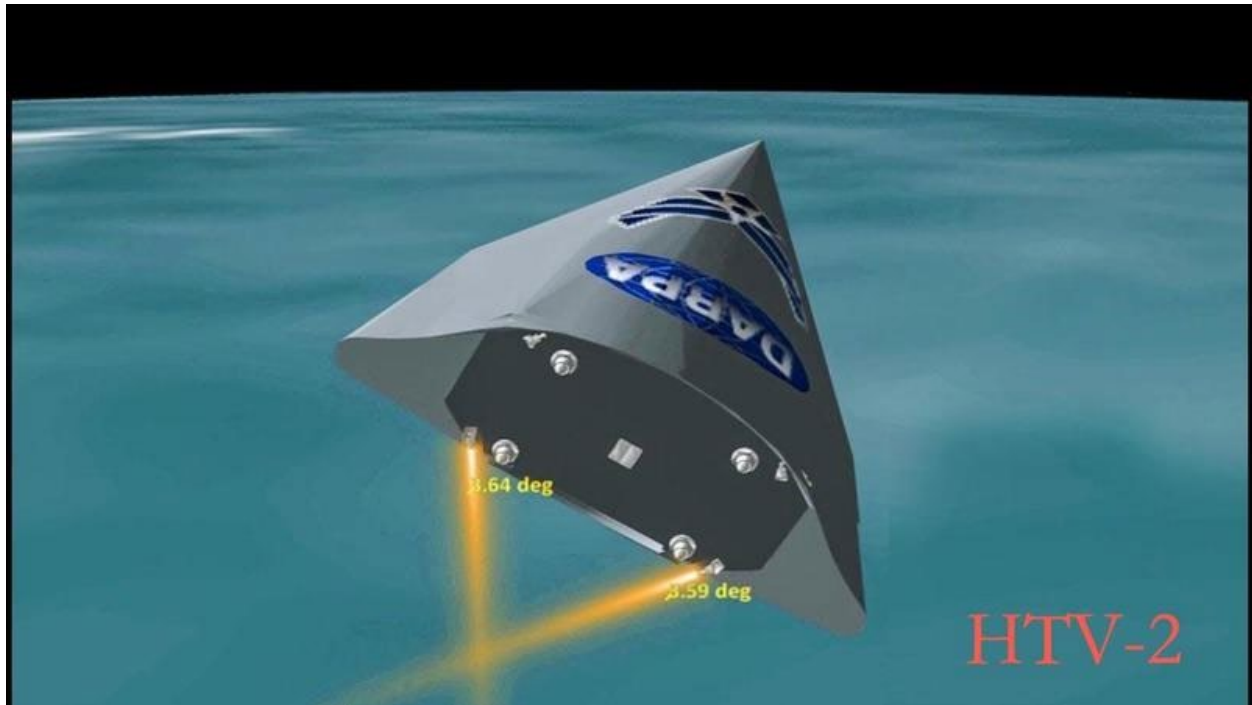

Figure 54. DARPA Falcon HTV 2 vision of USA Mach 22, 13,000 mph, supersonic vehicles development. Falcon HTV-2's speed is insufficient to escape Earth's gravity. Escape velocity is around 25,000 mph. Lockheed Martin Corporation's HTV-2 is made of carbon composite material. The surface temperature of the HTV-2 is expected to reach 1,930 °C (3,500 °F) or more in flight. Steel melts at 1,370 °C (2,500 °F). HTV-3X vehicle, known as [Blackswift](#), would be a reusable Hypersonic Cruise Vehicle, an unmanned aircraft capable of taking off from a conventional runway with a 5,400 kg (12,000 lb) payload to strike targets 16,650 km away in under 2 hours.

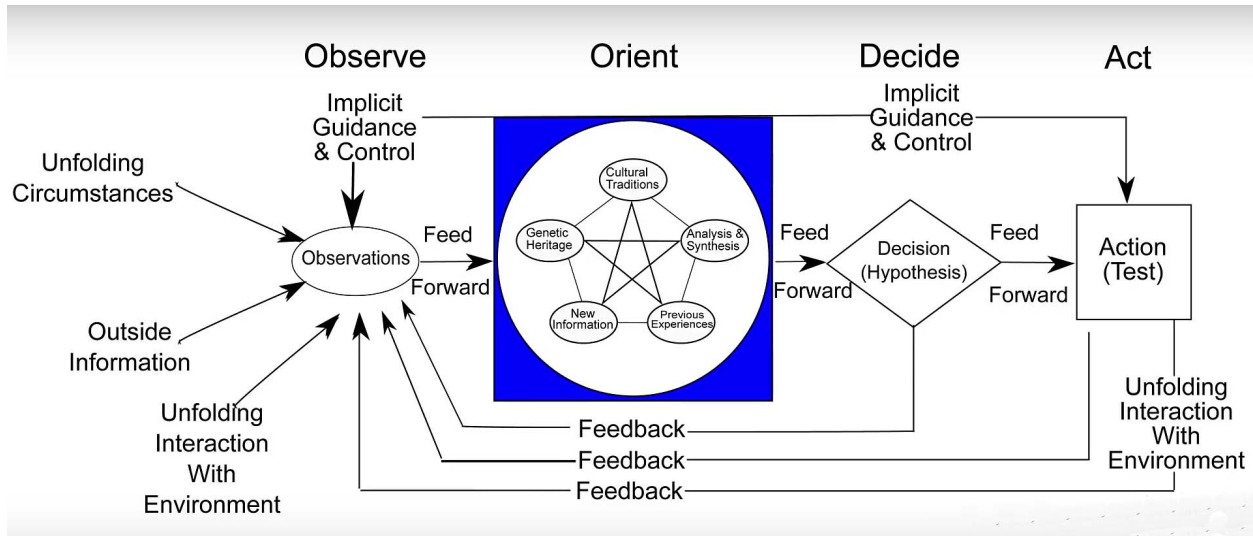

Figure 55. Observe Orient Decide Act, OODA control loop.

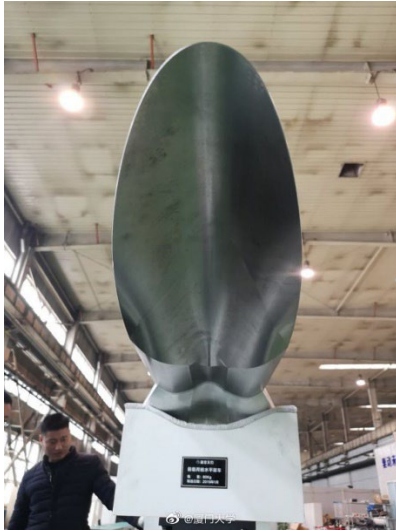

Figure 56. Lasers on high flying aircraft as a defense against hypersonic vehicles are not affected by atmospheric conditions.

CIVILIAN HYPERSONIC DOUBLE WAVE RIDER XTER-1 XIAMEN UNIVERSITY

The XTER-1 is developed under the Program: “Propulsion System TBCC for Civilian Platforms,” (民机涡轮基组合动力系统), which aims at increase the speed of current aircraft by a factor of five to reach any point on the globe within a 2 hours span.

Xiamen University has conceptualized the “Double Waverider” Configuration since 2007.



天行I 结构分解图



图 1 模型外形及其特征尺寸(单位:mm)

Fig.1 Model configurations (unit:mm)

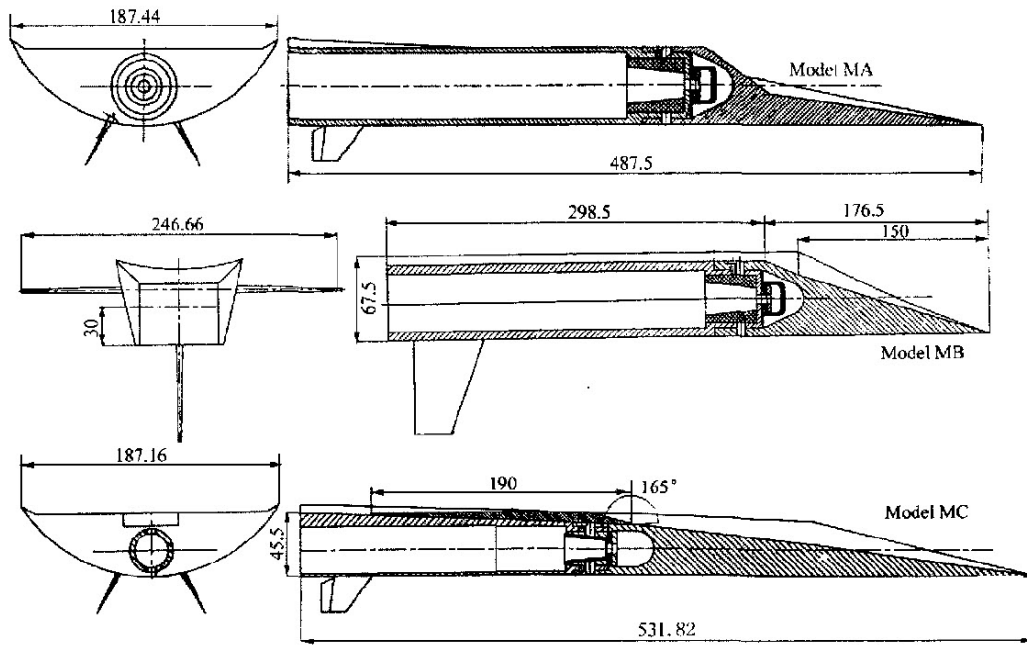
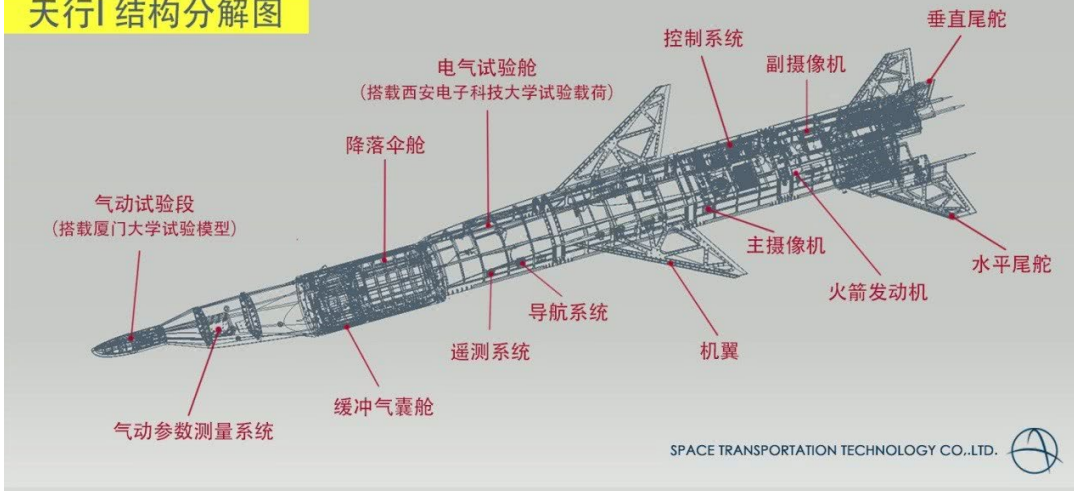
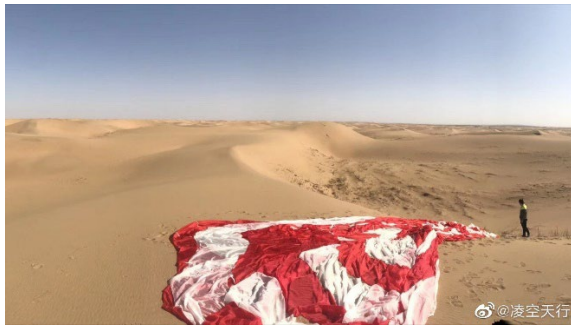
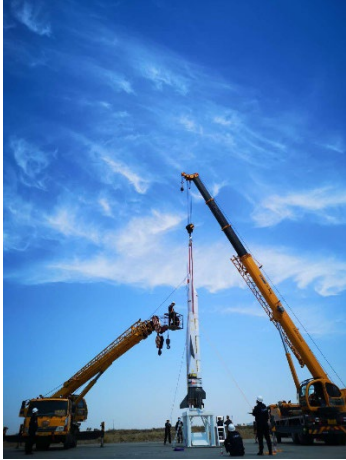

Figure 57. Retrievable “Double Wave Rider” XTER-1 at XIAMEN University flew 400 secs at a height of 27.4 km reaching a speed of Mach 5.5-6.0 which was reduced to Mach 0.35 into a maneuverable glider mode part of the flight. Source: East Pendulum.

DF-17 HYPERSONIC GLIDE VEHICLE, HGV

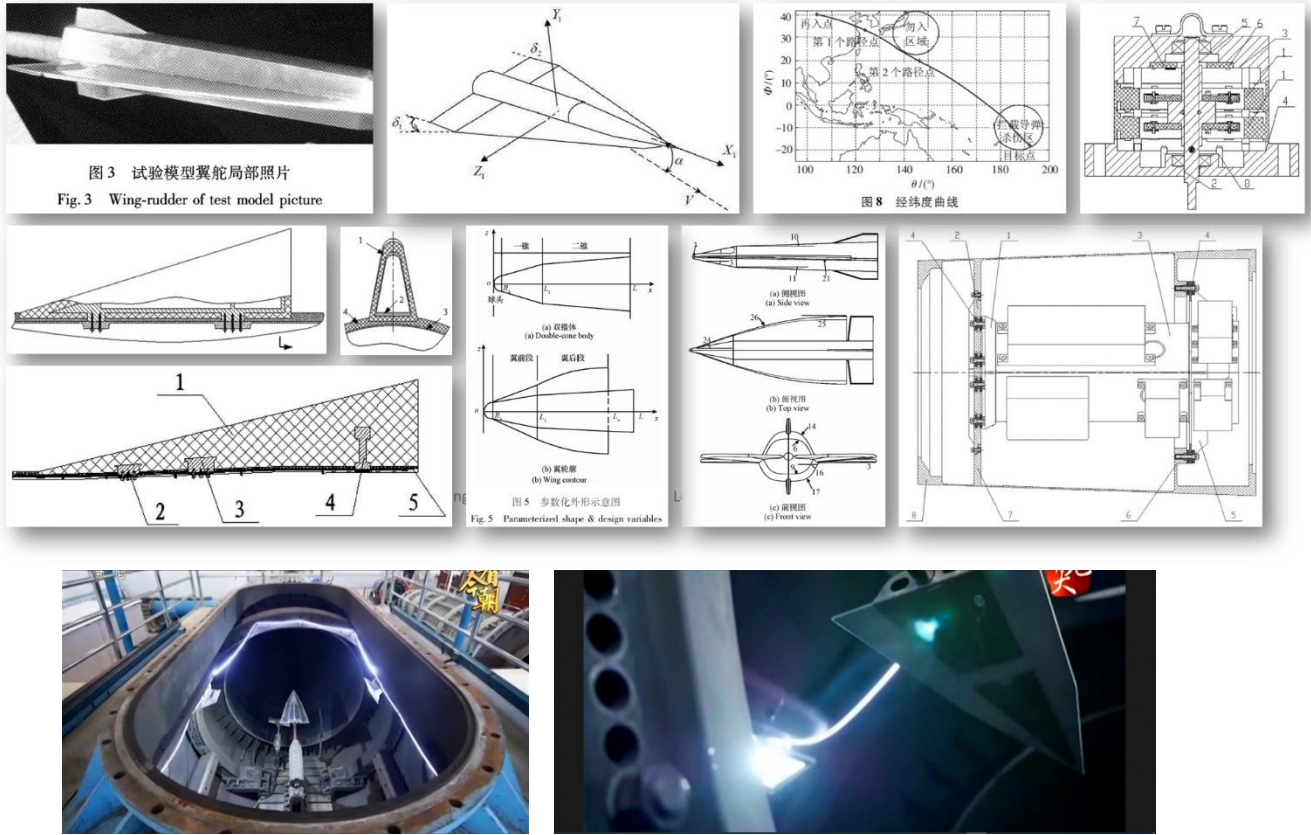
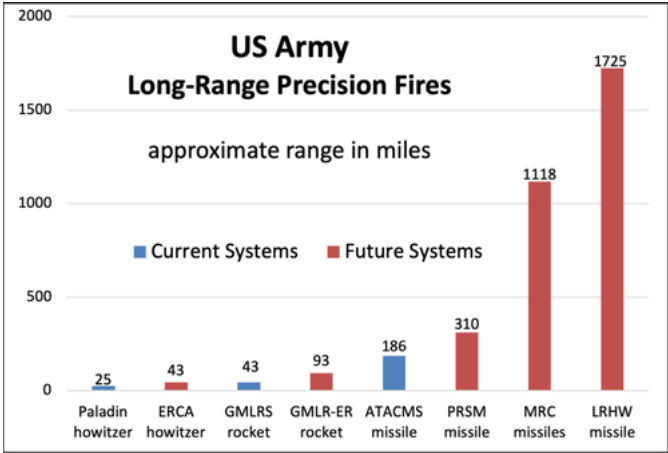

Figure 58. Hypersonic Glide Vehicle DF-17 wind tunnel testing.

USA HYPERSONIC GLIDE VEHICLE



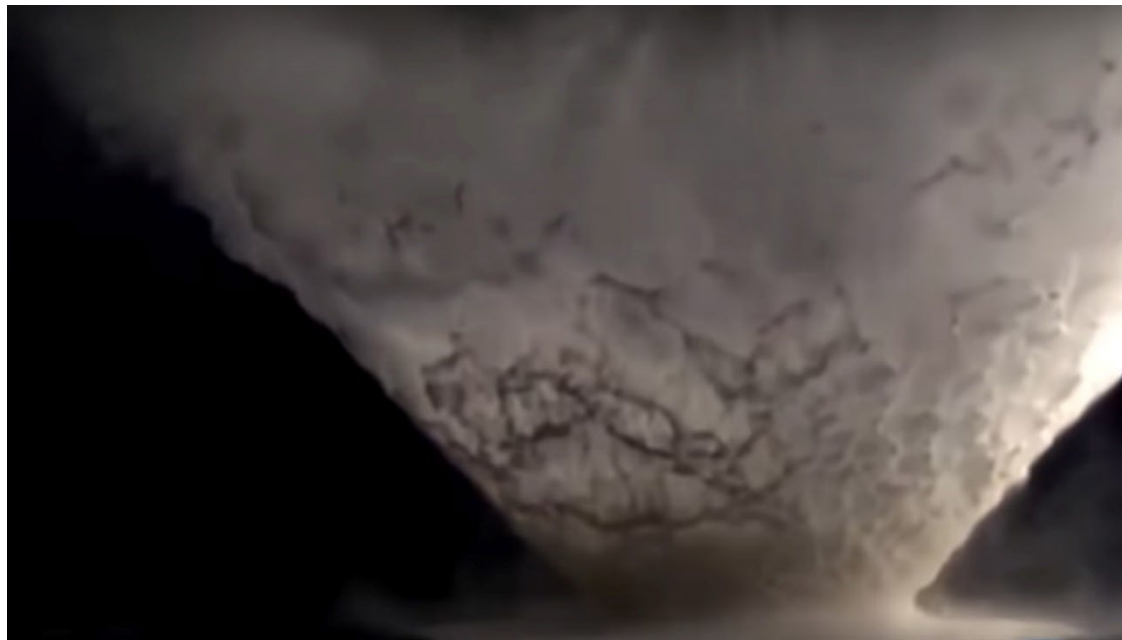

Figure 59. USA Hypersonic Glide Vehicle LRHW. The Long Range Hypersonic Weapon LRHW provides a capability at a distance greater than 2,775 km (1,727 miles). NASA hypersonic impact test by NASA.

The USA Army revealed the official range of its hypersonic boost-glide missile, otherwise known as the Long Range Hypersonic Weapon, or LRHW. The Long Range Hypersonic Weapon provides a capability at a distance greater than 2,775 km (1,727 miles),

In comparison, the Mid-Range Capability (MRC) missile has a distance of approximately 1,118 miles. The LRHW'S 1,727 miles range gives the Army about 600 miles of additional striking

distance. The LRHW missile system consists of a rocket booster with a boost-glide warhead on top. The rocket launches the boost-glide vehicle to the desired altitude, and the vehicle then zooms to its target at hypersonic speed (or above Mach 5).

Hypersonic boost-glide vehicles can outmaneuver some of the world's most advanced missile defense shields due to their high degree of maneuverability.

HYPERVELOCITY PROJECTILES



5" Compatible HVP

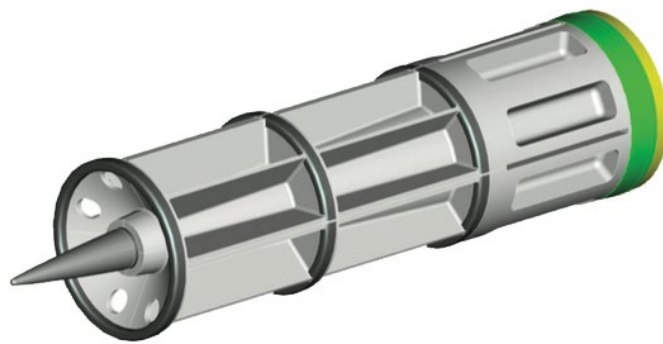

155-mm Compatible HVP



EM Railgun Compatible HVP

Figure 60. Hypervelocity projectiles use high density Tungsten cores. Source: BAE systems.

The USS *Dewey* (DDG-105) fired hyper velocity projectiles (HVP) from a standard Mk 45 5-inch deck gun in an experiment that is set to add new utility to the weapon found on almost every USA warship. The test, conducted by the Navy and the Pentagon's Strategic Capabilities Office as part of the Rim of the Pacific (RIMPAC) 2018 international exercise, was part of a series of

studies to prove the Navy could turn the more than 40-year-old deck gun design into an effective and low-cost weapon against cruise missiles and larger unmanned aerial vehicles.

While the HVP was originally designed to be the projectile for the electromagnetic railgun, the Navy and the Pentagon see the potential for a new missile defense weapon that can launch a guided round at near-hypersonic speeds.

The HVP is being investigated to use with ground-based 155 mm artillery pieces for the Army and the Marines to provide limited air defense options for forward-deployed troops in austere environments. The HVPs could also find a home aboard the Navy's Zumwalt-class destroyers as a replacement round for the classes 155mm Advanced Gun System.

HVP's low drag aerodynamic design enables high velocity, maneuverability, and decreased time-to-target. It takes 300 seconds to pick up a launched missile's signature, the missile must be tracked and a vector calculated for defensive projectiles. A single 25-pound projectile can dispense more than 500 three-gram tungsten impactors and be fired at hypervelocity by "electromagnetic" energy. Their impact force—their mass times the square of their velocity—can destroy expensive missiles and multiple warheads.

NEW COMMERCIAL SUPERSONIC TRAVEL ERA, BOOM/UNITED AIRLINE



Figure 61. "Overture" Boom/United Airlines supersonic plane concept [3].

At a price tag of \$200 million per-plane, USA airline United is buying 15 new supersonic airliners for deployment in the year 2029 [3]. Supersonic passenger flights ended in 2003 when Air France and British Airways retired the Aérospatiale/BAC Concorde, the British-French turbojet-powered supersonic passenger airliner from service. The new Overture aircraft will be produced by the Denver, Colorado company Boom. The company expects Overture to be profitable for airlines even if tickets are sold for the same price as a "regular business-class fare" [3].

Supersonic flight at an altitude of 60,000ft (18,300m), implies flying faster than the speed of sound at that altitude of 660 mph or 1,060 km/h. In comparison typical passenger cruises at about 560 mph (900 km/h), The Overture concept is expected to reach speeds of 1,122 mph (1,805km/h)

or Mach 1.7. At that speed, travel time on transatlantic routes such as London to New York can be cut in half to 3.5 hours instead of the current 7 hours [3].

Two major challenges face supersonic passenger travel: noise and pollution. Travelling faster than the speed of sound causes a sonic boom, which can be heard on the ground as a loud thunderclap or explosion. The Boom Company says it is confident that its plane will not be any louder than other modern passenger jets while taking off, flying over land and landing. It also hopes improvements in aircraft design since Concorde will help it reduce and mitigate the sonic boom [3].

The second issue is fuel consumption. Boom's plan is for Overture to run entirely on Sustainable aviation fuel (Saf). "Power-to-liquid" processes, where renewable energy such as wind power is used to produce liquid fuel is an option.

The Concorde is thought to have been profitable for British Airways in its final years of operation. The wealthiest travelers instead of travelling first class on a commercial jet with the public, they can charter compact private planes that fly on demand, directly to-and-from their airports of choice. Avoiding the check-in desk and luggage carousel can shave time off travelling too [3].

HYPERSONIC AIR FORCE ONE

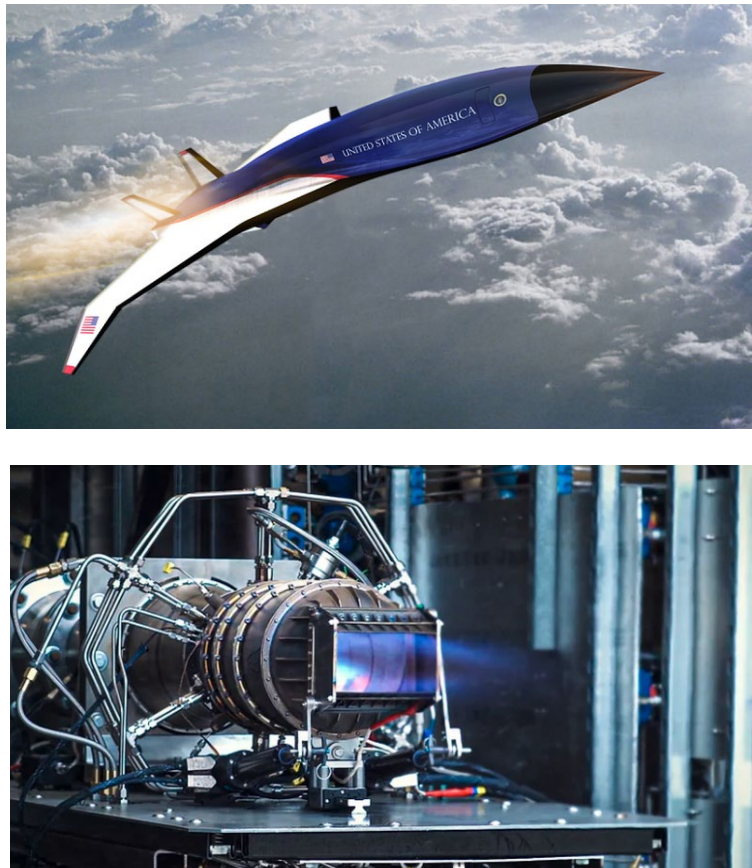

Figure 62. Hypersonic Air Force 1 presidential concept and engine test bed. Source: Hermeus.

The USA Air Force and the Presidential and Executive Airlift Directorate announced they have partnered with an Atlanta-based company called Hermeus to develop a hypersonic Air Force One. The partnership will allow for the development of a hypersonic aircraft for the presidential fleet, that can travel as fast as Mach 5. Hermeus successfully tested a Mach 5 engine prototype earlier this year. A demonstrator vehicle using the Mach 5 engines could be seen within the next five years.

Mach 5 is about 3,300 mph, would travel 2.5 times faster than the Aérospatiale/BAC Concorde and about 43 percent faster than the Virgin Galactic Holdings' proposed supersonic jet:

“Hermeus Corporation, the aerospace company developing Mach 5 commercial aircraft, has partnered with the U.S. Air Force and the Presidential and Executive Airlift Directorate to work toward hypersonic travel for the Department of Defense. This award comes under an Other Transaction For Prototype Agreement Direct to Phase II contract through AFWERX after Hermeus successfully tested a Mach 5 engine prototype in February 2020.

The effort is focused on rapidly assessing modifications to Hermeus Mach 5 aircraft to support the Presidential and Executive Airlift fleet. Early integration of unique Air Force requirements for high-speed mobility and evaluation of interfaces between high-speed aircraft and existing communications, airport, and air traffic control infrastructure lays the groundwork for a seamless transition to service. Additionally, Hermeus will prepare test plans to reduce technical risk associated with these modifications to support Air Force requirements.”

Brigadier General Ryan Britton, Program Executive Officer for Presidential and Executive Airlift, commented on the project:

"Leaps in capability are vital as we work to complicate the calculus of our adversaries. By leveraging commercial investment to drive new technologies into the Air Force, we are able to maximize our payback on the Department of Defense investments. The Presidential and Executive Airlift Directorate is proud to support Hermeus in making this game-changing capability a reality as we look to recapitalize the fleet in the future."

OVERCOMING THE STAGNATION POINT USING THE LORENTZ-LAPLACE FORCE IN A FARADAY ACCELERATOR

The use of a Faraday accelerator using perpendicular electric and magnetic fields can accelerate the flow at the stagnation point in hypersonic flight hence suppressing shock wave formation, wave drag and heating.

The Lorentz-Laplace equation states according to the cross product vectorial law that:

$$\vec{F} = \vec{J} \times \vec{B}$$

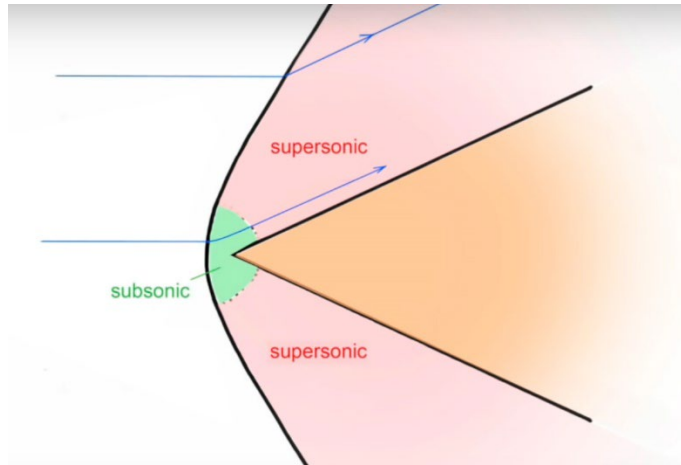

three fingers' law



$$\vec{F} = \vec{J} \times \vec{B}$$

segmented electrodes

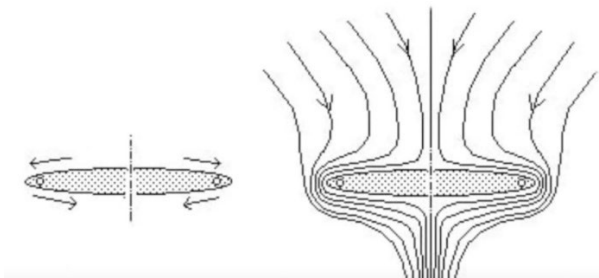
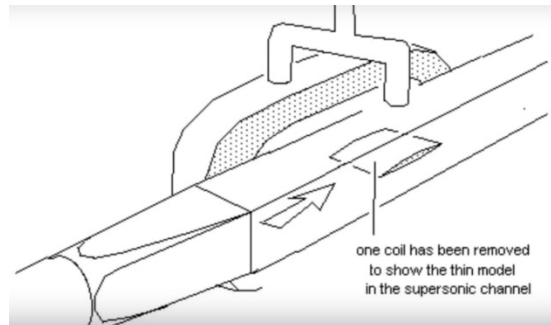
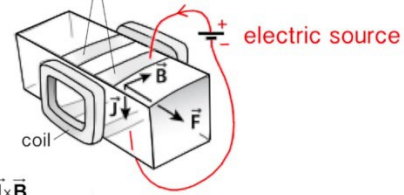

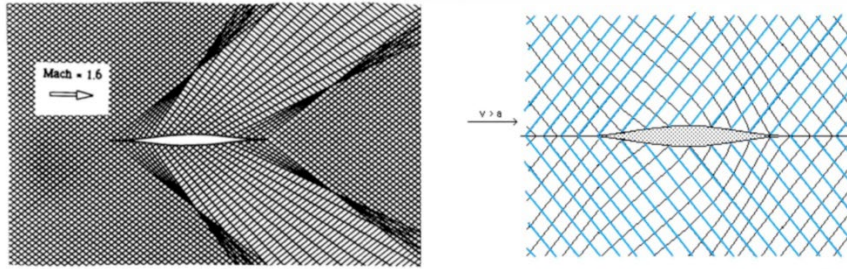

Figure 63. The use of the Faraday Accelerator in Magneto Hydro Dynamics (MHD) Lorentz-Laplace force $F = J \times B$ using perpendicular electric field J and magnetic field B would avoid the formation of the stagnation point and suppresses shock wave formation and heating, hence provide an engine plasma acceleration of 800 g for a hypersonic engine. Flow around thin wing in the absence of the $J \times B$ force at Mach = 1,5 (left) and Mach lines from the effect of the $J \times B$ force (Right). Source: Jean-Pierre Petit.

NUCLEAR SPACE PROPULSION, THE LAST FRONTIER

o-ph] 18 May 2018

SPACEFLIGHT FROM SUPER-EARTHS IS DIFFICULT

MICHAEL HIPPE¹

¹Sonneberg Observatory, Sternwartestr. 32, 96515 Sonneberg, Germany

ABSTRACT

Many rocky exoplanets are heavier and larger than the Earth, and have higher surface gravity. This makes space-flight on these worlds very challenging, because the required fuel mass for a given payload is an exponential function of planetary surface gravity. We find that chemical rockets still allow for escape velocities on Super-Earths up to $10 \times$ Earth mass. More massive rocky worlds, if they exist, would require other means to leave the planet, such as nuclear propulsion.

1. INTRODUCTION

Do we inhabit the best of all possible worlds (Leibnitz 1710)? From a variety of habitable worlds that may exist, Earth might well turn out as one that is marginally habitable. Other, more habitable (“superhabitable”) worlds might exist (Heller & Armstrong 2014). Planets more massive than Earth can have a higher surface gravity, which can hold a thicker atmosphere, and thus better shielding for life on the surface against harmful cosmic rays. Increased surface erosion and flatter topography could result in an “archipelago planet” of shallow

where m_0 is the initial total mass (including fuel), m_f is the final total mass without fuel (the dry mass), and v_{ex} is the exhaust velocity. We can substitute $v_{ex} = g_0 I_{sp}$ where $g_0 = G M_{\oplus} / R_{\oplus}^2 \sim 9.81 \text{ m s}^{-2}$ is the standard gravity and I_{sp} is the specific impulse (total impulse per unit of propellant), typically $\sim 350 \dots 450 \text{ s}$ for hydrogen/oxygen.

To leave Earth’s gravitational influence, a rocket needs to achieve at minimum the escape velocity

$$v_{esc} = \sqrt{\frac{2GM_{\oplus}}{R_{\oplus}}} \sim 11.2 \text{ km s}^{-1} \quad (2)$$

Figure 64. Exploration of other planets would require nuclear propulsion.

The real defense against hypersonic vehicles will be from space. The satellites will pick up the infrared heat signatures of the launches and even a few minutes warning will allow a naval fleet to disperse its ships. The hypersonic vehicles will miss by miles at Mach 8. Killing the adversary’s satellites will deny control signals to the vehicles slow up in a pop-up to receive data as they typically have an ionized plasma skin that impedes radio signals when they enter the envelope of some current Surface to Air Missiles (SAMS).

DISCUSSION

There are currently no effective defenses against hypersonic weapons because of their speed and maneuverability. They can hug the ground at 500 feet below long range radars beams and hence escape detection. This is in contrast to ballistic missiles which possess predictable trajectories determined by momentum and gravity.

The USA Air Force in August 2018 awarded \$480 million to Lockheed Martin Missiles & Fire Control to develop a hypersonic weapon prototype that would travel five times faster than the speed of sound to overcome Russian and Chinese missile defense systems. The contract covers the critical design review, test, and production readiness support for the Air-Launched Rapid Response Weapon (ARRW).

The AARW program now consists of two hypersonic weapon prototyping efforts administered by the Air Force to expedite hypersonic research and development. Lockheed was awarded the first \$929 million contract on April 18, 2018, which was for the design and manufacture of the Hypersonic Conventional Strike Weapon (HCSW), a new air-launched weapon system.

Officials from the Defense Department, Missile Defense Agency, Air Force, Navy, and Army signed a memorandum June 28, 2019 to work jointly on the development of “hypersonic boost-glide” technology.

The ARRW effort is ‘pushing the art-of-the-possible’ by leveraging the technical base established by the Air Force/[Defense Advanced Research Projects Agency] partnership,” the release said. “The HCSW effort is using mature technologies that have not been integrated for an air-launched delivery system.”

In late 2017, China conducted several tests of a hypersonic-BGV glide vehicle that could be used to defeat U.S. missile defense systems. China has successfully tested its new aircraft, the Starry Sky-2, which can even be used to carry nuclear missiles at a speed never seen before. The arms race in hypersonic weapons has ushered in the next Cold War between the USA, Russia, and China.

On March 28, 2018, USA General John Hyten addressed the 32nd Space Symposium. As head of the USA Strategic Command, he warned in an interview with CNN that China and Russia are working to produce new hypersonic weapons that the USA currently cannot defend against:

"China has tested hypersonic capabilities. Russia has tested. We have as well. Hypersonic capabilities are a significant challenge. We are going to need a different set of sensors in order to see the hypersonic threats. Our adversaries know that."

India's Brahmos II is a ramjet system developed with Russian design help. It might include a little chip imbedded in it that will cripple it when judged necessary like in most other weapons systems and computers reserved for export markets.

The USA Government Accountability Office (GAO) published a report about hypersonic weapons, including Hypersonic Glide Vehicles (HGVs) and Hypersonic Cruise Missiles (HCMs), and their development as the race for hypersonic technology heats up with Russia, China and India.

Hypersonic weapons fly between Mach 5 (3,836 mph) and Mach 10 (7,672 mph) and have the ability to outmaneuver the world's most advanced missile defense systems, such as the USA MIM-104 Patriot and Russian S-400 missile system. The HGVs and HCMs fly at lower altitudes and unpredictable flight paths than a traditional ballistic missile that flies typically at a predictable arch trajectory from launch to target. Hypersonic weapons have extreme maneuverability capabilities which make it difficult to defend against them. GAO said HGVs are hypersonic gliders that are initially propelled with a rocket to altitudes between 25 and 60 miles. High-speed engines power HCMs during the entire flight. Can fly at altitudes between 12 and 19 miles. According to GAO:

"For most HCMs, a rocket would accelerate the missile to Mach 3 or 4, and then the HCM's own ramjet or supersonic combustion ramjet (scramjet) engine would take over. A ramjet uses the speed of the vehicle to "ram" and compress air with fuel, which is burned to produce thrust. A scramjet is similar, with air moving at supersonic speed."

The GAO cited a recent update from the USA Air Force Scientific Advisory Board that said: "the core technologies needed for the development of a tactical range HGV have reached Technology Readiness Level (TRL) 5 out of 9. The board expected the remaining subsystems for such a weapon to reach TRL 6 or higher by 2020. According to GAO best practices, TRL 7 is the level of technology maturity that constitutes a low risk for starting system development. It indicates that technology has achieved form, fit, and function, and has been demonstrated in an operational environment."

GAO lists several important features of hypersonic weapons, and how these weapons will make warfighting against major adversaries easier:

“Penetrate defenses: Hypersonic weapons would likely enable U.S. warfighters to penetrate existing adversary anti-aircraft and anti-missile systems because of their speed, maneuverability, and altitude (above typical anti-aircraft defenses and below interception points for ballistic reentry vehicles).

Strike fleeting targets: The speed of hypersonic weapons would allow them to hit targets that are only vulnerable for a limited time, such as mobile, high-value military targets and adversary weapons systems.

Agile targeting: A traditional missile needs to be launched with a target in mind, but a hypersonic weapon could be maneuvered later in flight. This could provide U.S. decision-makers more time and make it extremely difficult for adversaries to prepare.

High travel speeds: Piloted hypersonic vehicles would allow for very short travel times and may have commercial applications. Such vehicles have essentially been limited to certain spacecraft reentering the atmosphere and experimental aircraft.”

GAO lists the challenges of developing a hypersonic weapon:

“Heat-tolerant materials: At hypersonic speeds, the exterior temperature of a hypersonic vehicle or weapon can exceed 2,000°F, necessitating advanced materials that will protect interior electronics. Such materials also need to be mechanically strong and efficient.

Propulsion technology: Refinement of engine technology is needed for HCMs. This includes increasing the reliability and efficiency of scramjet engines. New types of engines that allow for propulsion from standstill to hypersonic speeds are also being developed, which would eliminate the need for rockets to provide the initial launch.

Weapon tracking: Defense against a hypersonic weapon would involve tracking and intercepting it, but current radar and satellite systems are inadequate for this task.

Limited testing resources: There are limited places to perform ground tests and flight tests of hypersonic weapons and vehicles in the United States. Currently, there are limited wind tunnel facilities in the country capable of running propulsion tests of hypersonic weapons and vehicles.

Safety and control: Hypersonic velocities require additional improvements of aircraft control and guidance to help ensure the accuracy of hypersonic weapons.”

Within the Department of Defense (DOD), several top-secret programs by the Defense Advanced Research Projects Agency (DARPA), the Air Force, the Navy, and the Army have received billions of dollars in the last several years to develop hypersonic weapons. GAO warns that these technologies are not mature and it could take time until deployment.

Meanwhile, Russia and China have been testing and deploying such weapons, signaling that the U.S. is rapidly losing its global air supremacy, and another reason why the world is marching closer to war.

Deterrence with other systems such as the existing nuclear triad of land-based Intercontinental Ballistic Missiles (ICBMs), strategic bombers and submarine-launched ballistic missiles is an available counterweight. Laser defenses have limited capability in unfavorable weather conditions and electromagnetic guns have a limited line of sight capability.

The USA Air Force in 2015 awarded Northrop Grumman a \$23-billion contract to develop the new B21 bomber as a partial replacement for the service’s existing fleet of around 160 B-1, B-2 and B-52 bombers. The B-21 is believed to be somewhat smaller than the B-2, with a payload of around 30,000-pounds, just large enough to carry one GBU-57 Massive Ordnance Penetrator precision-guided conventional bomb, the largest in the Air Force inventory. The USA Air Force has stated that the B-21, which will be capable of nuclear and conventional roles, would have a pilot-optional mode, effectively transforming it into a remotely-operated drone with the flip of a few switches. An unmanned platform is subject to hacking a platform carrying devastatingly powerful nukes. An enemy hacking a B-21, landing it and taking possession of the nukes is not an acceptable risk. Northrop is building the bomber at a secretive facility in Palmdale, California that

previously manufactured Global Hawk spy drones. The service expects each bomber to cost around \$600 million.

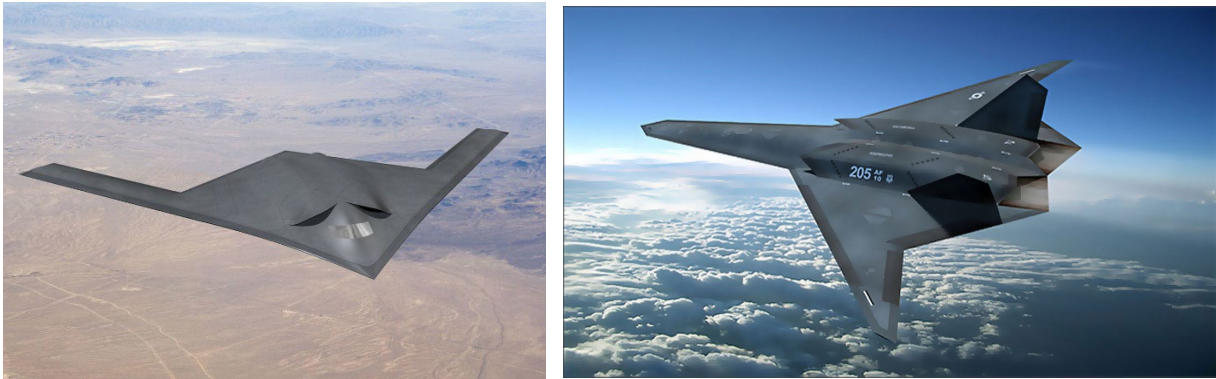

Figure 65. Boeing and Lockheed-Martin NGB Next Generation Bomber strategic bombers concepts.



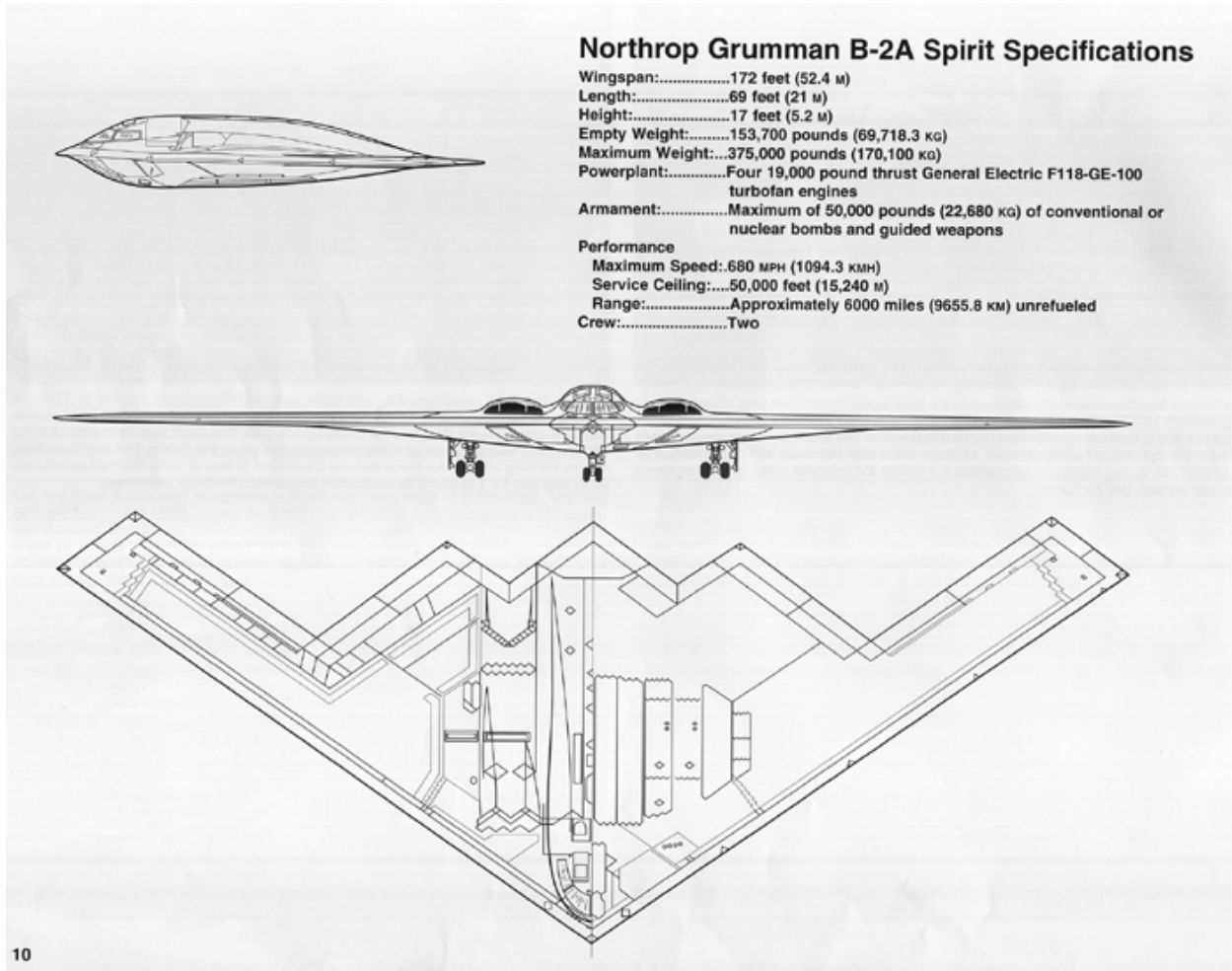
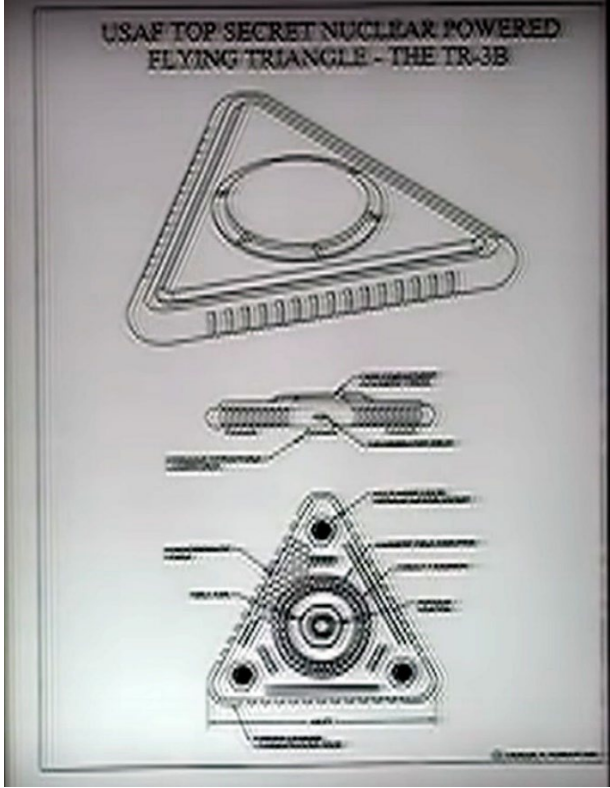

Figure 66. Northrop Grumman B-2A Spirit may be using a plasma sheath as a stealth feature in addition to the electro-active control surfaces shown lighted up in flight.



Figure 67. B2 Spirit and B21 Raider Stealth High Altitude Northrup-Grumman strategic bombers. The B-21 has been labeled as an “optionally manned” aircraft, meaning it can fly with or without a crew. Source: Northrup-Grumman.





By: GURUVC
GIMATED 11-27-2009

THREE GRAVITY CONTROL

In real world conditions, such as The Gerasimgensuodhasek of The Arkharsars, which are in many ways a new leader in Soviet Russia, references regarding details of the proposed underlying functioning and construction of systems as well as the use of liquid Mercury for their propulsion can be found. From the choice of Mercury as fuel, it is possible to conclude that the energy source was nuclear power.

Various were spacecraft and space vehicles used in recent days several thousands years ago.

Today, every mechanical engineer knows that the gyroscopes, which are widely used as stabilization mechanisms in navigation equipment, ships, missiles and space vehicles among other things, and which nearly consist of smaller or greater mass rotating at high speed rates of the order of 100,000 r.p.m., in operation lose a fraction of their own stationary mass.

In his article, Guidelines to Antigravity written in 1960 and published in American Journal of Physics in 1960, Dr. Robert L. Forward from Hughes Research Laboratories, looking from the known aspects of Einstein's General Relativity Theory, describes how "heavy" matter can create unusual gravitational effects, giving its usual gyroscopic effect a subtle new meaning.

Antigravity motion of massive rings, he has shown that, in order to achieve measurable gravitational effects with moderate amounts of mass, matter of extremely high density (somewhere from 10¹⁶ to 10²⁰) grams must be used. As it is impossible, at present, to create such densities, the material must be used in a manner that requires structural rigidity of itself (depending only on strength of its material, he proposed the use of liquid gas suspended in extremely low temperature and conductivity strong magnetic fields).

In the case of the matter it may be possible to use its magnetic moment and the initial rotation, which are contained in order to control interacting electromagnetic fields (induced magnetic fields and extraordinary gravitational fields).

He concludes that research in the field of generation will be very difficult since even the most optimistic calculations indicate that very large densities will be required to create usable gravitational forces and that future progress in the control of generation, that of nuclear materials, will require special concepts involving large sums of money, time, and energy. It is noted that external arrangements for this purpose should be that of a corresponding blank sheet. For original article click on Download of a static gravitational field usage above.

In 1999 a Finnish scientist of Russian origin, Eugene Podolskiy, claims to have built a device that produces a gravity-repelling effect. It consists of a flat, non-spherical, 12-inch (30-centimeter) disk of a superconducting ceramic, rotating within a magnetic field. (Click on the disk, Podolskiy reports, shows a loss of weight of between about 0.5 percent and 2 percent.)

Using test devices involving weak magnetic fields produced by superconductors.

So there it is in small words that, in his article "Weightless Materials" NASA Funds Controlled Society. So there it is in small words that, in his article "Weightless Materials" NASA Funds Controlled Society.

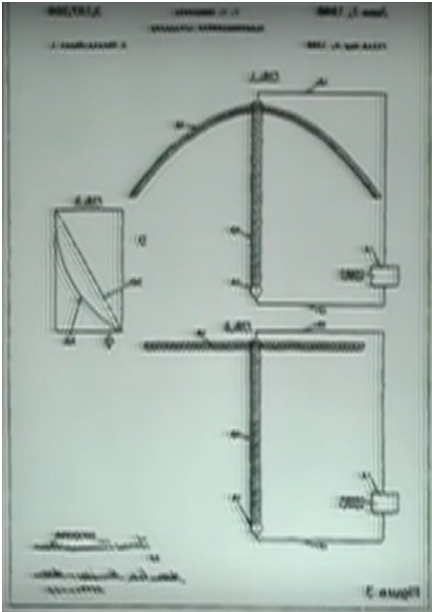

Figure 68. Alleged nuclear stealth aircraft configurations. The conical shape supposedly is creating lift through rotation. The triangular TR3 B supposedly uses magneto hydrodynamics to create lift through interaction with the earth's magnetic field and rotating superconducting materials. Ionic breeze patent.



Figure 69. Aurora X-43A hypersonic experimental vehicle aircraft configurations.

Concerning stealth, during the Iraq Desert Storm war, the USA bombed the TV station in Baghdad because of the possibility that the Iraqi military may have figured out how to triangulate in a passive-way stealth airplanes using the extensive commercial microwave TV and communications towers emissions background.

Tracking is the real problem, not shooting them down. If you can track hypersonic stealth aircraft, you can shoot them down. So instead of what one thinks of as a standard radar set that can track a missile, one instead needs a net that covers 100 percent of the defended area instead of the area you are around or moving in. Commercial microwave towers provide such an option, and act passively as well. If one has a wide area point defense system, such as with lasers and rail guns, one can shoot the hypersonic vehicles down after locating them.

To defend against them, a space-based sensor system that would be able to track Hypersonic Glide Vehicles globally would be needed with some additional system to engage them. A one hundred percent coverage on military radar requires space-based systems. Their infrared heat signature from their ablating protection skins rather than their radar signature would be easily detectable from space sensors. Hot ablating hypersonic missiles can be detected a very long way out, by space sensors and F-35 DAS and ground IR sensors, and will provide the time margin needed for SAM interceptors like Army THAAD or Navy SM6, or ABM interceptors, with much faster and more agile turning capabilities, to get close to it and kill it.

The USA, Russia, and China are developing hypersonic systems, as well as France, India, and Australia. Japan and various European countries are working on civilian uses of the technology, such as space launch vehicles and civilian airliners.

APPENDIX I

NEW ARMS RACE. RUSSIAN STAR WARS WISH LIST [2]

In a bid for his reelection, President Vladimir Putin of Russia, in a repeat of President Ronald Reagan Star Wars initiative; gave a speech to the Russian Duma on March 1st 2018, outlying the development and deployment of six new weapon systems by the Russian military. It must be noted that Russia and China both have a history of exaggerating their weapon capabilities.

The aim of the six new directions of superweapons is to negate the effectiveness of the Anti-Ballistic Missile, ABM system that the USA surrounded Russia with. President George W. Bush in 2002 has withdrawn the USA from the treaty. The elimination of a retaliatory response by an ABM system makes the possibility of a decapitating first strike possible. The six high technologies comprise:

1. Sarmat RS-28 Super-heavy ICBM

An ICBM, Intercontinental Ballistic Missile System using nuclear Multiple Independently targeted Reentry Vehicles (MIRV) of large size of 200 tons: the RS-28 Sarmat with NATO designation SS-X-30 Satan-2. It replaces the RM-36M Voevoda with NATO designation is SS-18, Satan.

It uses a hypergol or hypergolic propellant with two components which spontaneously ignite when they come in touch with each other. Hypergolic propellants are difficult to handle because of their corrosiveness and toxicity. They can be stored as liquids at room temperature, Hypergolic rocket engines are easy to ignite reliably and repeatedly. The most common combinations are dinitrogen tetroxide plus hydrazine and its derivatives: monomethyl hydrazine and unsymmetrical dimethyl hydrazine.

It is difficult to detect in flight with a low orbit of 150 km, compared with classical ICBMs with an orbit height of 1,200 km. It has a long 11,000 km range capable of a South Pole trajectory avoiding detection by the ABM system installed for a North Pole trajectory.

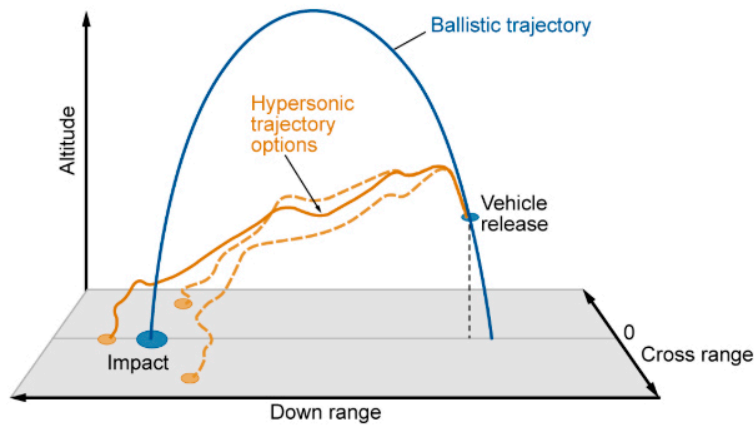
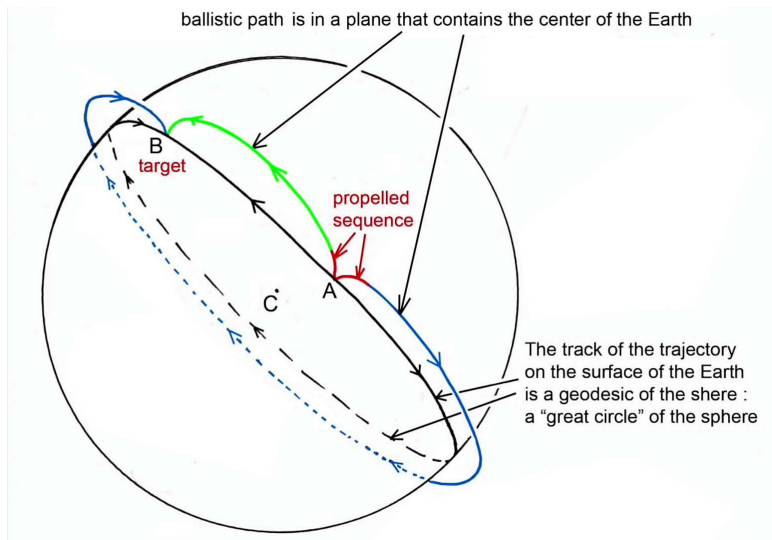

Source: GAO. | GAO-19-705SP

Figure 1. Ballistic missiles trajectories choices through North and South Poles.

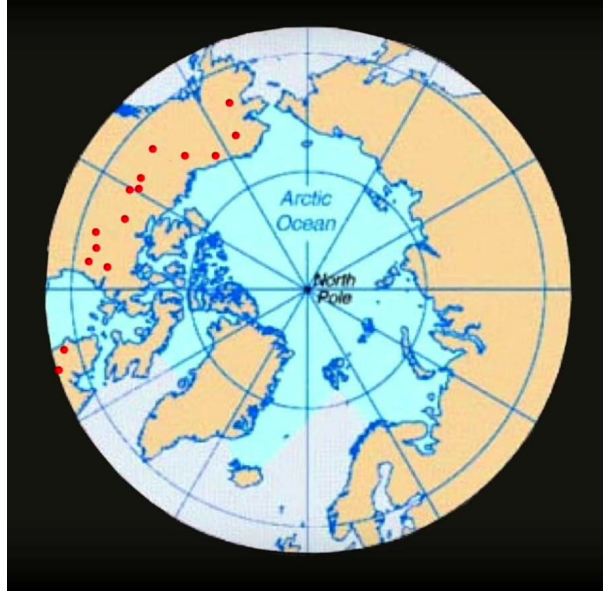

Figure 2. A north pole ICBM trajectory can be intercepted by the NATO/USA ABM system.



Figure 3. An ICBM South Pole trajectory avoids the installed ABM system.



Figure 4. The Sarmat mobile ICBM.

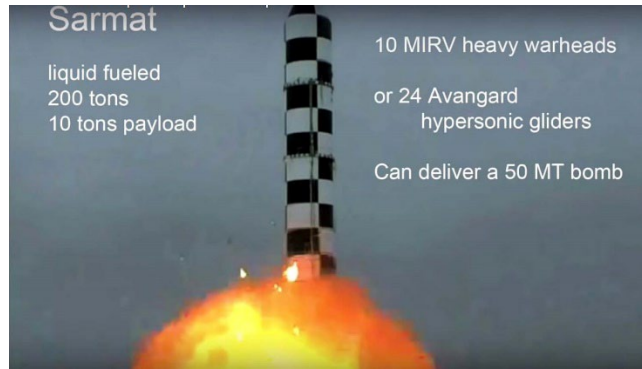

Figure 5. Properties of the Sarmat ICBM.

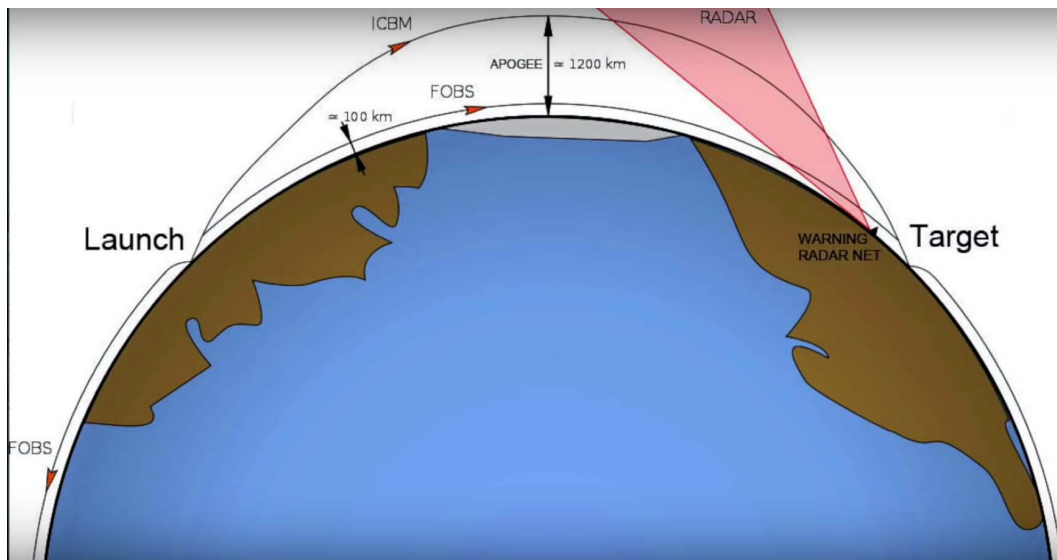

Figure 6. A North Pole low orbit (100 km) Fractional Orbital Bombardment System (FOBS) ICBM or cruise missile trajectory reduces the radar warning time compared with a high ICBM orbit (1,200 km) trajectory.

2. Burevestnik nuclear-powered Scramjet supersonic and “unlimited range and unlimited ability to maneuver” low altitude cruise missile

Russia's Burevestnik is nuclear-powered cruise missile with a NATO designator as SSC-X-9 SKYFALL. A Supersonic Low Altitude Missile (SLAM) powered by a miniature unshielded disposable nuclear reactor would hug the terrain, can loiter for a long time, and possess unlimited range since it heats the inlet and may not need a chemical propellant.

This is the Russian equivalent of the USA studied Pluto Project. Its speed would be between Mach 3 to 4.





Figure 7. Burevestnik nuclear-powered ramjet launch using a rocket and assembly line. Source: Russian Defense Ministry.

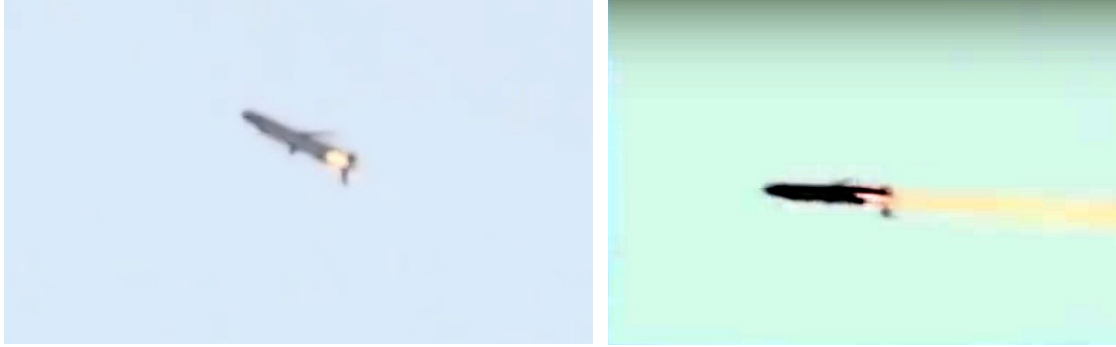

Figure 8. Zircon 3M22 scramjet cruise missile in flight testing.

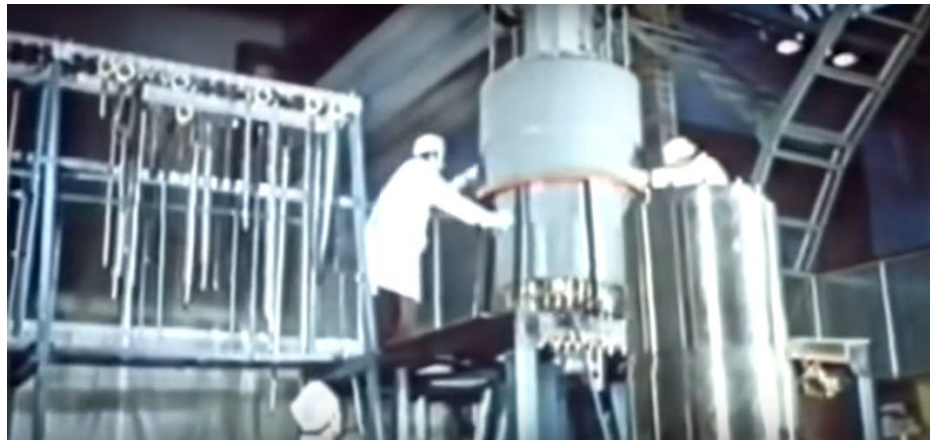
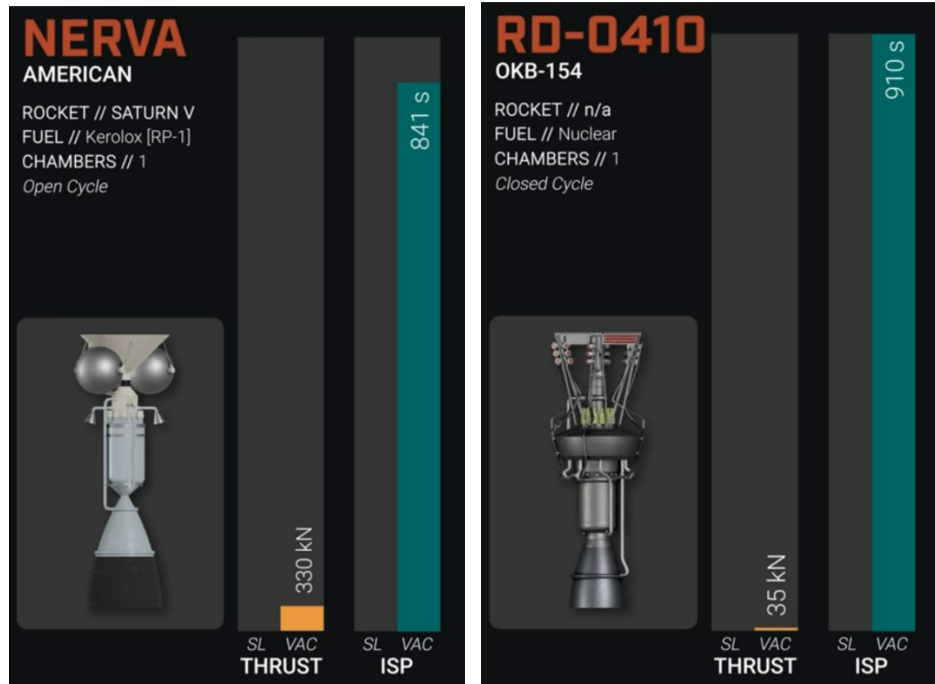

Figure 9. Comparison of USA and Russian RD-0410, OKB-154 Nuclear rockets. Russian rocket appears small enough and of lower hydrogen thrust of 35 kilo Newtons for small rocket delivery. SL: Sea level, VAC: Vacuum, ISP: Specific Impulse.

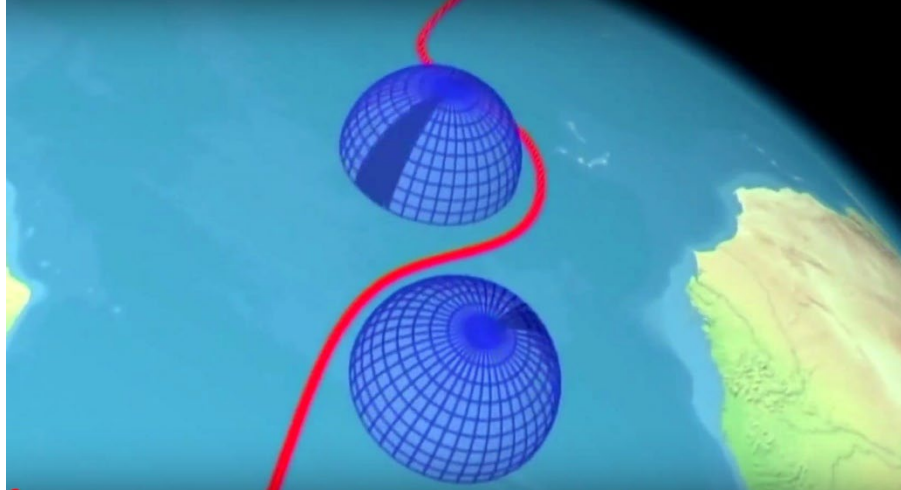

Figure 10. Radar evading cruise missile.

3. Nuclear Unmanned Underwater Vehicle UUV, Kanyon Status-6

Since it can carry a large nuclear payload reaching a 50-100 MT device, it can target coastal cities and marine installations by an intense tsunami.

Its silent operation is possibly attributed to a magneto-hydrodynamic propulsion system powered by the nuclear reactor.

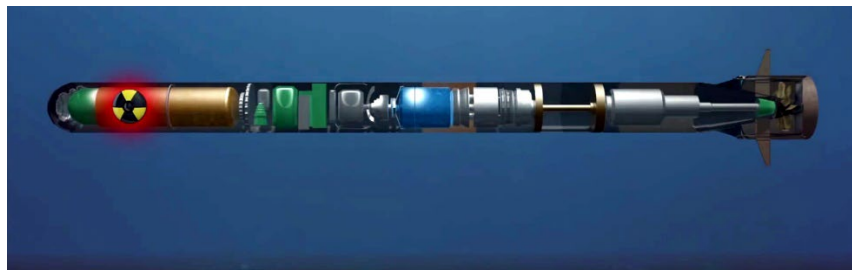

Figure 11. Two versions of autonomous nuclear torpedoes.

4. Kinzhal, Dagger Kh47M2 hypersonic transported system

This is claimed to be a hypersonic Mach 10 system that would be impossible to intercept with existing rockets. It would operate as a ramjet or scramjet. Its launch vehicle would be a supersonic jet. It could carry nuclear or conventional payloads. The Kinzhal (Dagger), is carried by MiG-31 fighter jets and entered service with the Russian air force in 2018. It flies 10 times faster than the speed of sound, has a range of more than 2,000 kilometers or 1,250 miles and can carry a nuclear or a conventional warhead. It is capable of hitting both land targets and naval platforms.

Its range would be 2,000 km with a short operation time of 10 minutes. To overcome the heat barrier at Mach 10, it may be surrounded by a plasma sheath. It would operate in the same fashion as the super-cavitation torpedo VA-111 Shkval. Its solid powder rocket exhaust gases would be diverted to the front, eliminating the shock wave and reducing the heating load. The generated enveloping plasma would be seeded with cesium to enhance its conductivity. The ionization would make it invisible to radar. The same principle of a plasma sheath may contribute to the stealth properties of the B2 bomber.





MISSILE KINJAL (DAGGER)

PHASE 2 : START HYPERSONIC MODE

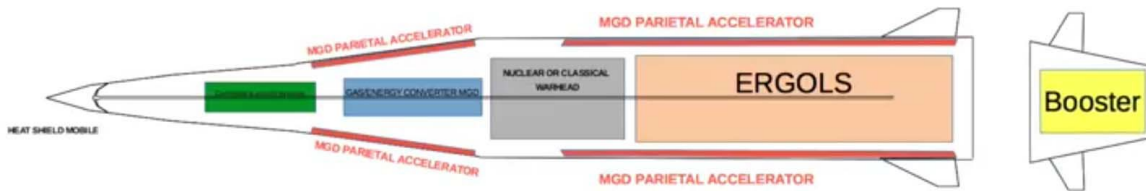

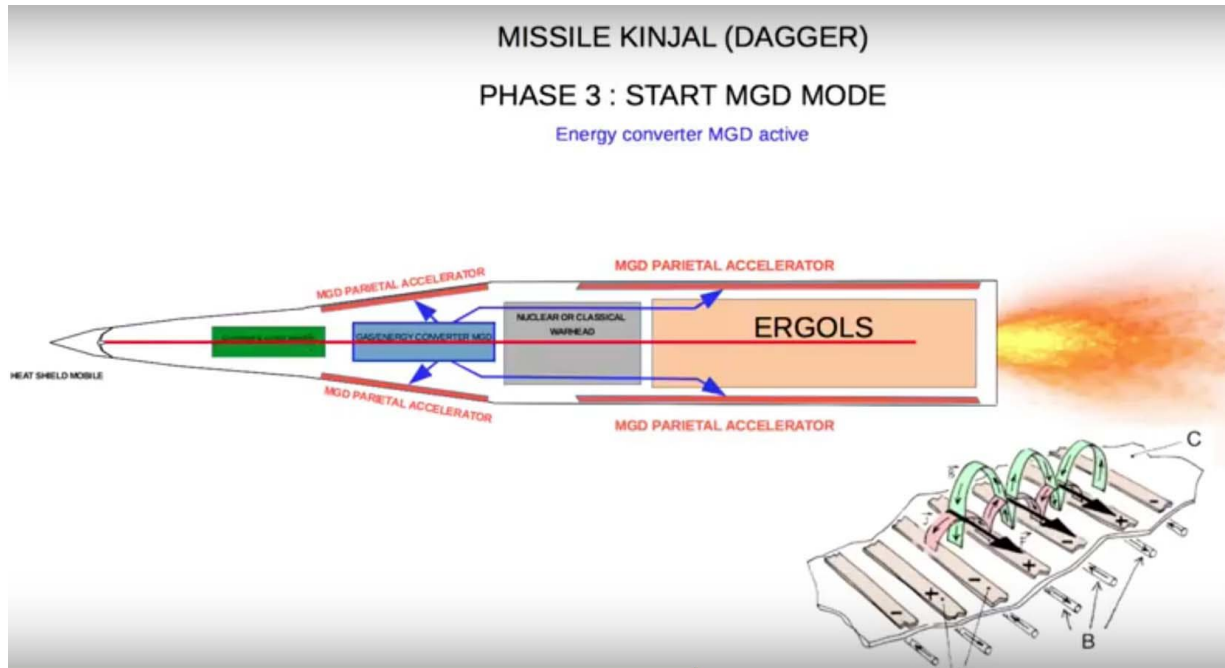

Figure 12. Kinzahl (dagger) cruise missile launched from the belly of supersonic aircraft.
 ERGOLS: French for propellant. MGD: Magneto Gas Dynamics.

5. Hypersonic Glide Vehicle (HGV) Mach 20 Avangard

Hypersonic technology poses a different threat from ballistic missiles because they could be maneuvered in ways that confound existing methods of defense and detection. Unlike most ballistic missiles, they would arrive to their targets in under 15 minutes, which is less time than anyone would need to meaningfully react. In December 2018, the Avangard was launched from the Dombrovskiy missile base in the southern Urals and hit a practice target on the Kura shooting range on Kamchatka, 6,000 kilometers or 3,700 miles away. The Avangard was placed on duty with a unit in the Orenburg region in the southern Ural Mountains in December 2019. It will first be mounted on Soviet-built RS-18B intercontinental ballistic missiles, bearing the NATO code-name SS-19. It is expected to be fitted to the prospective Sarmat heavy intercontinental ballistic missile (ICBM) after it becomes operational.

Avangard is designed using new composite materials to withstand temperatures of up to 2,000 degrees Celsius or 3,632 Fahrenheit resulting from a flight through the atmosphere at hypersonic speeds. It is capable of flying 27 times the speed of sound and carries a nuclear weapon of up to 2 Mt of TNT equivalent.

This would be a waverider type of cruise missile reaching Mach 20. It would be launched by a ballistic missile such as the RS-26 Rubezh or the RS-28 Sarmat into a ballistic orbit. It would then glide at high speed in the upper atmosphere with an unpredictable trajectory that is impossible to intercept toward its target “like a meteor”.

It possesses sharp leading edges leading to a non-detached frontal shock wave, in contrast to the space shuttle front. At Mach 10, the temperature immediately behind the shock wave would reach 20,000 degrees Celsius that no material can withstand. That needs the detachment of the

shock wave using a plasma sheath. The kinetic energy of the shock wave must be converted into electrical energy along the line of the supersonic Ajax jet design.

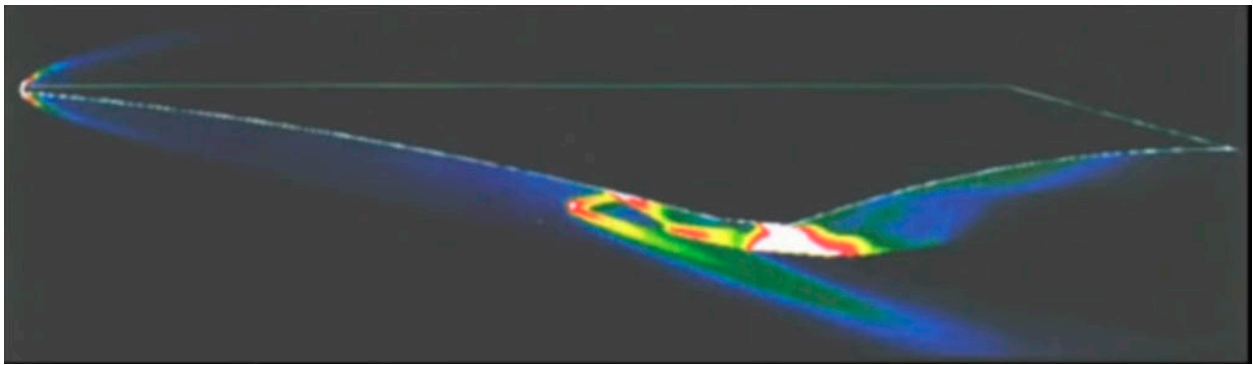
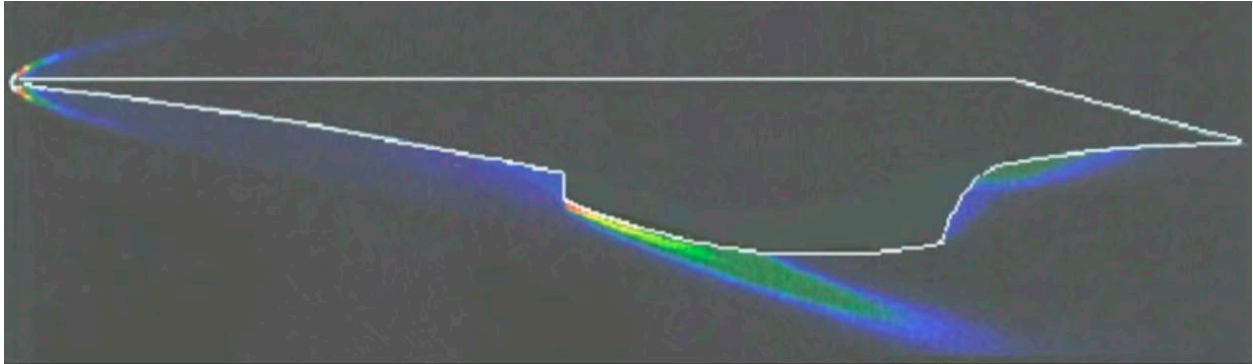

362

electron path in a plasma

Hall parameter :

$$\beta = \frac{e B}{m_e v_e} = \frac{\text{gyrofrequency}}{\text{collision frequency}}$$

$$\vec{J} = \sigma \vec{E} = \sigma (\vec{V} \times \vec{B})$$

electron path in a plasma

Hall parameter :

$$\beta = \frac{e B}{m_e v_e}$$

$$\vec{J} = \sigma \vec{E} = \sigma (\vec{V} \times \vec{B})$$

$\beta \ll 1$

$\text{tg } \theta = \beta$

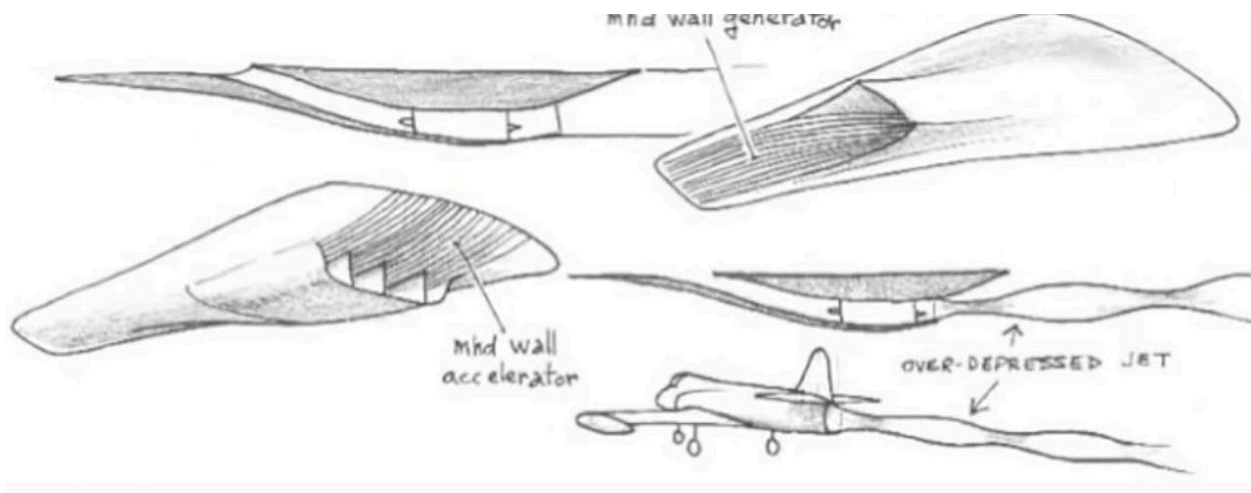
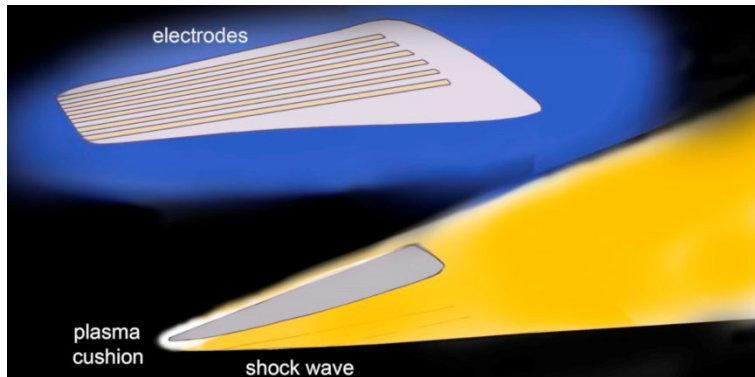
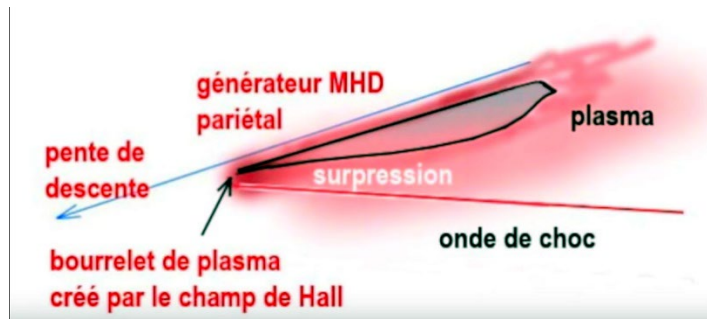
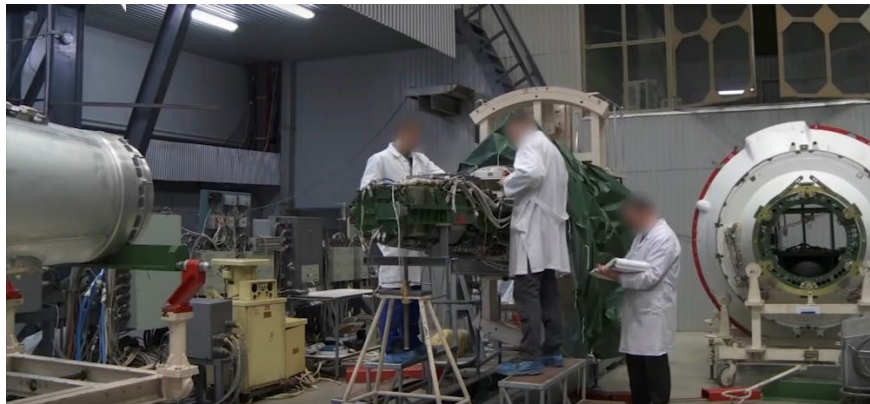
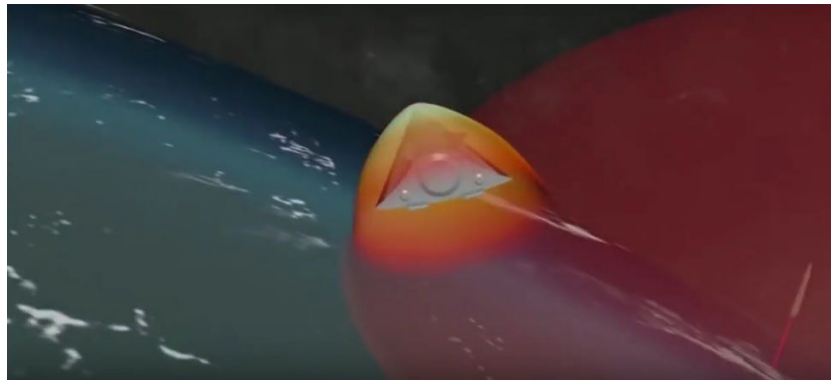
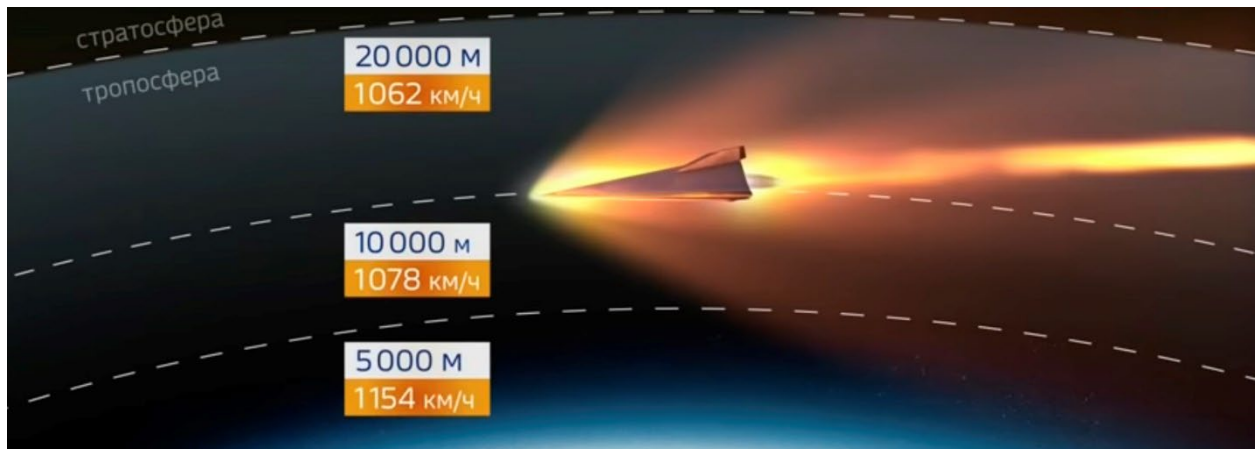

Figure 13. Wind tunnel testing of Russian AJAX spy plane design of supersonic jet, mirror image of USA Aurora project. Plasma conductivity can be enhanced by injection of Cs as a source of electrons. Source: Jean-Pierre Petit.



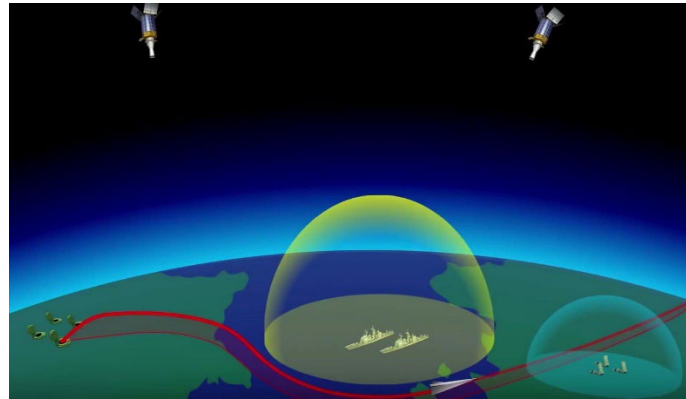
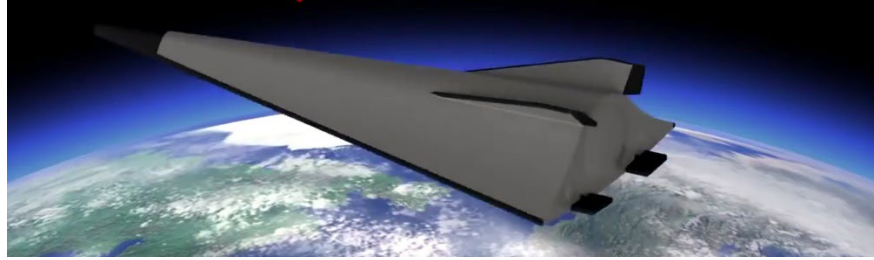

Figure 14. Hypersonic ballistic plasma sheath glider would plunge at its target like a meteorite uses satellite guidance. The Hypersonic Glide Vehicle (HGV), dubbed “Avangard” and also called ‘Objekt 4202’, Yu-71 and Yu-74, is fastened onto an intercontinental ballistic missile using scramjet engine technology. Once launched, the Avangard reaches speeds of Mach 20 and is equipped with “onboard countermeasures.” It is still unclear whether the hypersonic glide vehicle will carry explosives, due to the fact that Mach 20 capabilities alone can pack enough kinetic energy to annihilate its targets.





Figure 15. Avangard missile installation in silo.

The Avangard hypersonic boost-glide system went into production in the summer of 2018 to be operational with the 13th Strategic Missile Forces division by the end of 2019. It is deployed near Yasny, a town 502 kilometers or 312 miles southeast of Orenburg in the southern Urals Mountains. At least two regiments with six systems each are expected to be battle-ready by 2027. According to the state armaments program (GPV2027), twelve UR-100UTTKh (NATO: SS-19 Stiletto) missiles will be integrated into the Avangard hypersonic glide vehicles (HGVs). The deployment of the HGV might begin without additional flight tests. Eventually, the Sarmat RS-28 ICBM could be used to deliver the Avangard, potentially carrying a single, massive thermonuclear warhead with a yield exceeding 2 Mt of TNT equivalent.

The boost-glide weapon can fly at speeds of over Mach 20 or about 15,300 miles per hour or four miles per second. It could reach Washington D. C. in 15 minutes even if launched from Russia. It is hard to intercept it, as it moves in a cloud of plasma "like a meteorite." The weapon is distinctive for its ability to withstand extreme heat during the final phase of its trajectory thanks to its heat-resistant titanium casing. Its in-flight temperature reaches 1,600-2,000° Celsius. Carbon fiber can resist these temperatures.

It is difficult to predict the direction of its approach. Installed on the 200-ton Sarmat, the Avangard could be sent into the desired orbit at an altitude of 100 km from Earth using a pre-booster, gliding to its target at a speed of Mach 20 (5-7 km/s) while maneuvering with the help of stabilizers. It can make rapid course changes in the atmosphere. Its signatures are quite different from those of traditional ICBMs. Advanced countermeasure systems increase its ability to penetrate missile defenses.

The Avangard is the first HGV in the world to have gone into production, as well as the first to travel at great altitude in the dense layers of the atmosphere while deftly maneuvering. According to General John Hyten, head of USA Strategic Command: "We don't have any defense that could deny the employment of such a weapon against us."

The Serial production of Sarmat ICBMs is scheduled to begin in 2021. The UR-100N UTTKn and the Sarmat could carry multiple Avangard glide vehicles. Other ICBMs, such as the RS-24 Yars and RS-26 Rubezh, can potentially accommodate smaller Avangard-type vehicles should the New START Treaty not be extended. The tempo of the glide vehicle's deployment and modernization can be expedited depending on the progress of the talks with the USA on strategic nuclear arms. Since its trajectory renders the Avangard immune to missile-defense systems, the HGV is a powerful argument that would exist at the negotiating table.

Long-range, high-precision Hypersonic Glide Vehicles (HGVs) can be used in conventional conflicts to deliver prompt global strikes, including against those enemies who

possess the air- and missile-defense capabilities to counter aerial targets, cruise missiles, and smaller- and medium-range ballistic missiles. The conventional Avangard can be used with the same efficiency as nuclear delivery vehicles, thus making escalation to a nuclear phase unnecessary under certain circumstances. The HGV does not violate the New START Treaty or other international agreements.

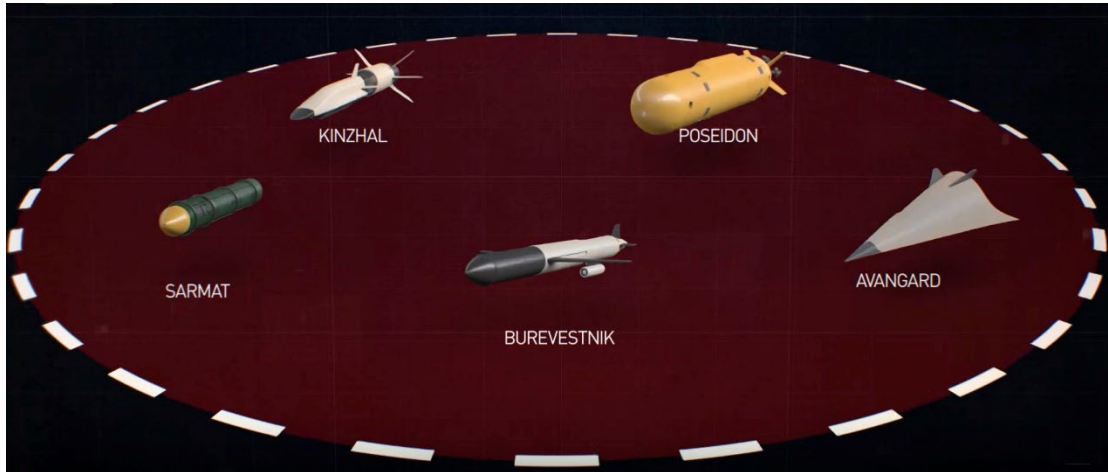

Figure 16. Synergetic interconnection between the new technologies.

6. Mobile Laser Canon

This is similar to the LaWS laser cannon deployed by the USA Navy on the USS Ponce. However, it is a mobile land-based system.



Figure 17. Mobile land-based laser cannon.

China tested its own hypersonic glide vehicle, believed to be capable of traveling at least at Mach 5. It displayed the weapon called Dong Feng 17, or DF-17, at a military parade marking the 70th anniversary of the founding of the Chinese state.



Figure 18. Dong Feng 17 missiles uses a hypersonic glide vehicle, HGV, Beijing, China.

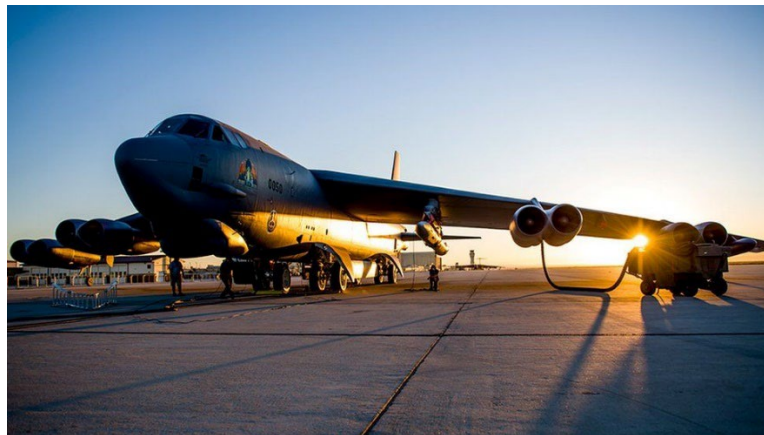

Figure 19. AGM 183 A undergoing testing, on B 52H Stratofortress, Lockheed-Martin. USA

USA officials as part of the newly establishes Space Force talk about placing a layer of infrared sensors in space to quickly detect enemy missiles, particularly the hypersonic weapons. Basing interceptors in space that can strike incoming enemy missiles during the first minutes of

flight when the booster engines are still burning is being studied. The development of hypersonic weapons is also being pursued by the USA in a new Arms Race in space.

APPENDIX II

DECAY SCHEMES OF POSITRON ANTIMATTER EMITTERS

Parent state: G.S.
 Half life: 109.77
 M(5)
 Q(gs): 1655.50(63)
 keV
 Branch ratio:
 1

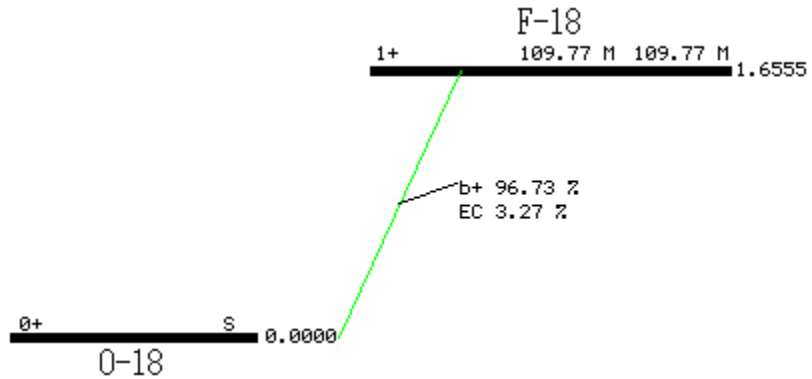

Beta+ ray: total intensity =96.7

Max.E(keV)	Avg.E(keV)	Intensity(rel)	Spin	
633.5(-)	249.8(3)	96.73(4)	1+	0+

Parent state: G.S.
 Half life: 1223.1 S(12)
 Q(gs): 1982.2(9) keV
 Branch ratio: 1.0

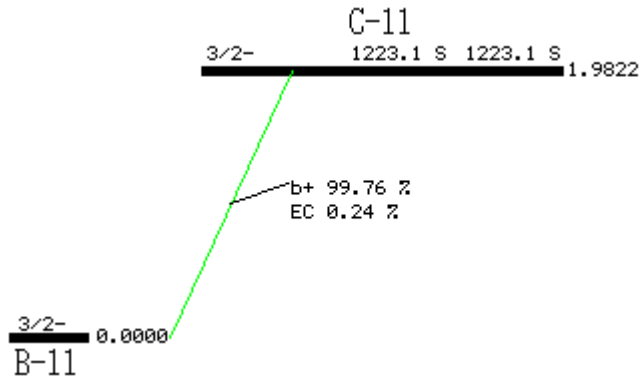

Beta+ ray: total intensity =99.8

Max.E(keV)	Avg.E(keV)	Intensity(rel)	Spin	
960.2(-)	385.6(4)	99.759(15)	3/2-	3/2-

Parent state: G.S.
 Half life: 9.965 M(4)
 Q(gs): 2220.49(27) keV
 Branch ratio:
 1

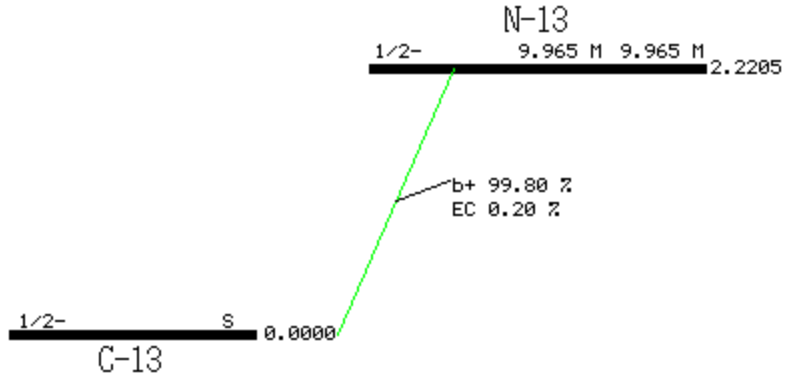

Beta+ ray: total intensity =99.8

Max.E(keV)	Avg.E(keV)	Intensity(rel)	Spin
1198.5(-)	491.82(12)	99.8036(20)	1/2-
			1/2-

Parent state: G.S.
 Half life: 122.24 S(16)
 Q(gs): 2754.0(5) keV
 Branch ratio: 1

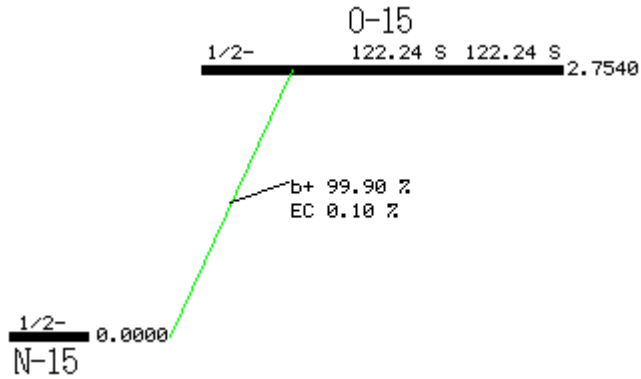

Beta+ ray: total intensity =99.9

Max.E(keV)	Avg.E(keV)	Intensity(rel)	Spin
1732.0(-)	735.28(23)	99.9003(10)	1/2-
			1/2-

EC: total intensity = 1.0e-01

22NA B+ DECAY

Parent state: G.S.
 Half life: 2.6088 Y(14)
 Q(gs): 2842.0(5) keV
 Branch ratio:
 1.0

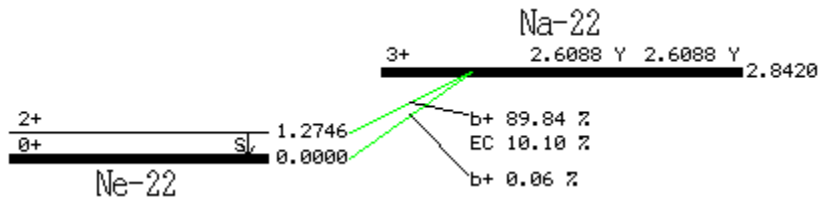

Beta+ ray: total intensity =89.9

Max.E(keV)	Avg.E(keV)	Intensity(rel)	Spin
1820.0(-)	835.00(23)	0.056(14)	3+
545.4(-)	215.54(21)	89.84(10)	0+
			2+

Gamma ray:

Energy (keV)	Intensity (rel)
1274.53 (2)	99.944 (14)

REFERENCES

1. Neil Gibson and Nikolai Novichkov, “Russian Aerospace Forces take delivery of ‘new’ Kinzhal air-launched ballistic missile,” Jane’s 360, March 19, 2018.
2. M. Ragheb, “Safeguards, Non Proliferation and Peaceful Nuclear Energy,” <http://mragheb.com/NPRE%20402%20ME%20405%20Nuclear%20Power%20Engineering/Safeguards%20Non%20Proliferation%20and%20Peaceful%20Nuclear%20Energy.pdf>
3. Chris Fox, “United plans supersonic passenger flights by 2029,” BBC News, June 4, 2021.